

WISENET

In-ceiling Housing

Installation Manual

SHD-3000F2





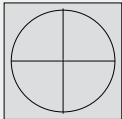

TABLE OF CONTENTS

Overview	3
What's Included	3
Installation Instructions	4
Installation (indoor type)	4
Product Specifications	8

OVERVIEW

This In-CEILING HOUSING is a mounting ADAPTOR that is designed to mount the smart dome camera in built-in style on a double-layer ceiling.

WHAT'S INCLUDED

		
HOUSING	SAFETY BRACKET (1EA)	SAFETY WIRE (1SET)
		
TEMPLATE (1EA)	outdoor type (3EA) indoor type (2EA)	INSTALLATION MANUAL

INSTALLATION INSTRUCTIONS

1. Select an installation position or place that can endure more than 4 times of the total weight of the installation structure.
2. At least 250mm or more of spare height is required above the **CEILING BOARD**.
3. **CEILING BOARD**'s thickness should be less than 40mm.
4. Be sure to secure the SAFETY WIRE to avoid a product fall.
5. If you want to attach the camera to the ADAPTOR, use the only provided SCREWS.

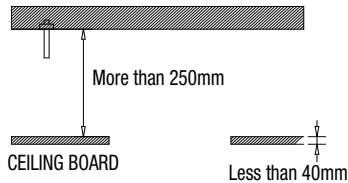

INSTALLATION (INDOOR TYPE)

1. Place the **TEMPLATE** on the **CEILING BOARD** and drill a guided hole.
 - 1 Remove the round filling ("C") from the **TEMPLATE**.
 - 2 Place **TEMPLATE A** onto the **CEILING BOARD** to which you will attach the ceiling mount ADAPTOR and drill a hole of $\varnothing 165\text{mm}$ in diameter.See the figure below for the hole shape.

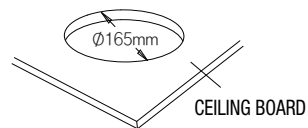
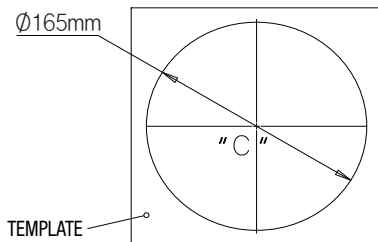

- Fix the **ANCHOR BOLT** onto the concrete **CEILING**, and secure the **SAFETY WIRE** to the **ANCHOR BOLT** as below:

- Tighten the nut ("N1") on the **ANCHOR BOLT**.
- Insert the provided **SAFETY BRACKET** into the **ANCHOR BOLT**.
- Tighten two nuts ("N2", "N3") onto the **ANCHOR BOLT**.
- Hook and fix one end of the **SAFETY WIRE** onto the **SAFETY BRACKET**.
- Hook and fix the other end of **SAFETY WIRE** onto the **HOUSING** as shown below.

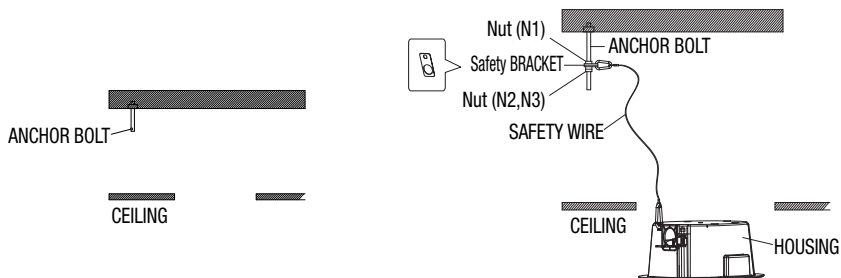

※ The ANCHOR BOLTS and nuts are optional and not included in the product package.

- To connect to the camera, insert the external cable through the side **hole** on the **housing** to the inside of the **housing** as shown in the figure.



- Refer to the installation manual of the camera that you want to install, and prepare necessary cables for camera connection.

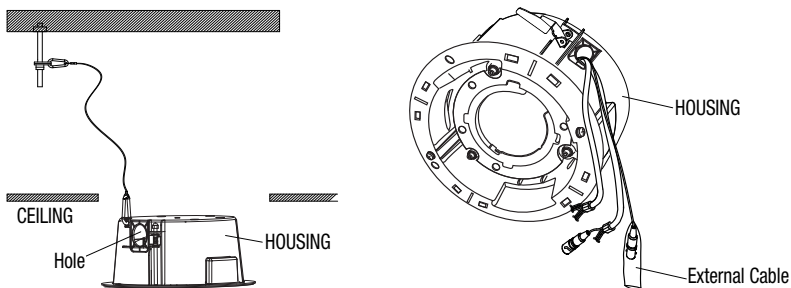

4. Push the **HOUSING** inside the **CEILING** through the **CEILING** hole, and tighten the **SCREWS** (x2) clockwise to fix the **HOUSING** on the **CEILING**.
(The **BRACKET** will be positioned from <A> to as shown.)



- Ensure that the **HOUSING** is firmly secured to the **CEILING BOARD**.

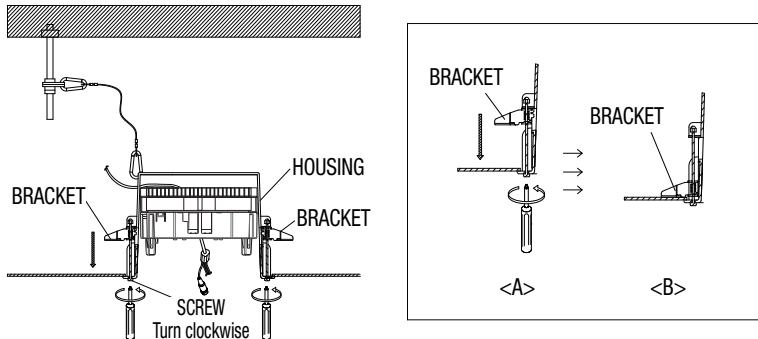

5. Remove the dome cover from the camera

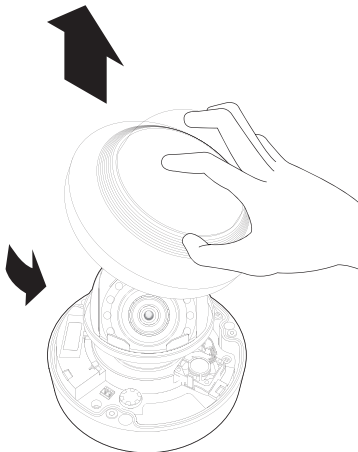

6. Installing the camera

Using the three screws, mount the camera in the housing.

※ When attaching the camera to the mount, check the arrow directions in the figure below before proceeding.

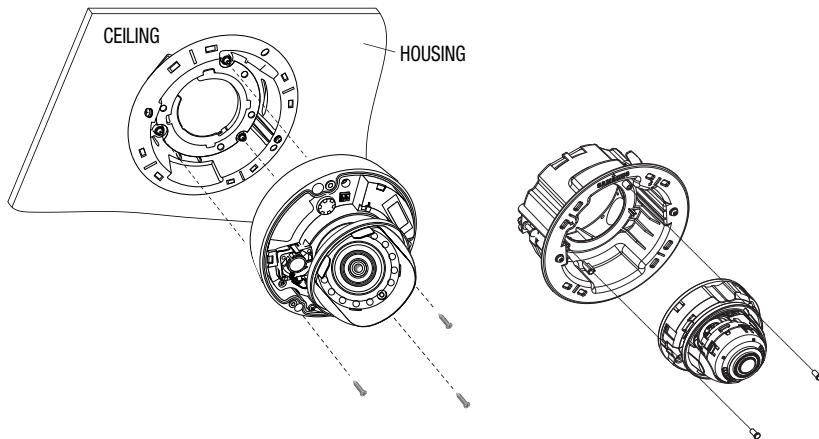

7. install the cover onto the HOUSING.

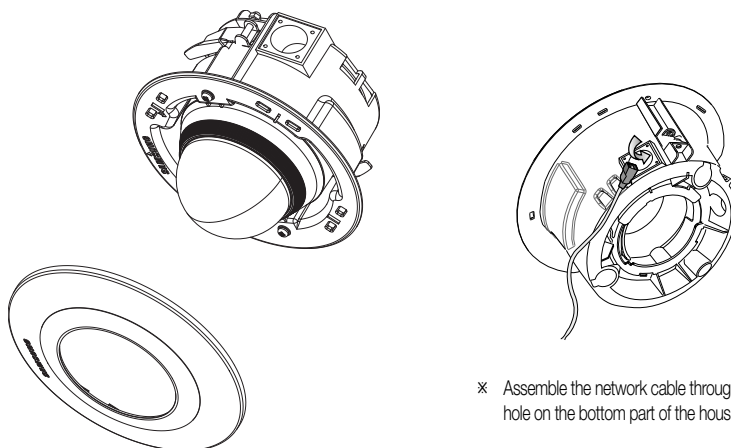

※ Assemble the network cable through the hole on the bottom part of the housing.

PRODUCT SPECIFICATIONS

Item	Specifications
Dimension (mm)	D194 X H102
Weight	350g
Temperature	-10°C ~ 50°C
Material	PC
Color	Ivory

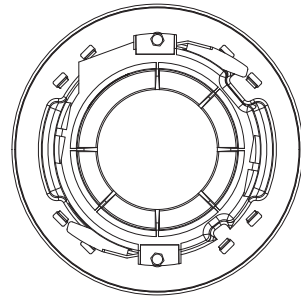
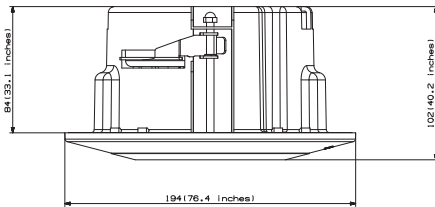

MEMO

Head Office

6, Pangyo-ro 319 beon-gil, Bundang-gu, Seongnam-si,
Gyeonggi-do, 463-400 Rep. of KOREA
Tel : +82.70.7147.8753 Fax : +82.31.8018.3740
www.hanwha-security.com

Hanwha Techwin America

500 Frank W. Burr Blvd. Suite 43 Teaneck, NJ 07666
Toll Free +1.877.213.1222 Direct +1.201.325.6920
Fax +1.201.373.0124
www.hanwha-security.com

Hanwha Techwin Europe

Heriot House, Heriot Road, Chertsey, Surrey, KT16 9DT, United Kingdom
Tel +44.1932.57.8100 Fax +44.1932.57.8101
www.hanwha-security.eu
