

# INSTALLATION BOX

## 제품 사용 설명서

SBP-300NB (IVORY)  
SBP-300NBW (WHITE)

### A급 기기(업무용 방송통신기자재)

이 기기는 업무용(A급) 전자파적합기기로서 판매자 또는 사용자는 이 점을 주의하시기 바라며, 가정외의 지역에서 사용하는 것을 목적으로 합니다.  
<https://www.HanwhaVision.com>

본 제품은 대한민국에서만 사용하도록 만들어져 있으며, 해외에서는 품질을 보증하지 않습니다.  
FOR KOREA UNIT STANDARD ONLY

# INSTALLATION BOX

## 제품 사용 설명서

---

### Copyright

©2019 Hanuaha Vision Co., Ltd. All rights reserved.

### Trademark

여기에 기재된 상표는 모두 등록된 것으로 이 매뉴얼에 기재된 이 상품의 이름과 다른 상표는 각 회사로부터 등록된 상표입니다.

### Restriction

이 문서는 저작권에 의해 보호됩니다. 어떠한 경우에도, 공식적인 동의 없이 이 문서의 전체 혹은 부분을 복제, 배포, 수정할 수 없습니다.

### Disclaimer

한화비전㈜은 이 문서에 수록된 정보의 완결성과 정확성을 검증하기 위해 최대한 노력하였으나 이에 대해 보증하지는 않습니다. 문서의 사용 결과에 따른 책임은 전적으로 사용자에게 있습니다.

한화비전㈜은 사전 예고 없이 이 문서의 내용을 변경할 수 있습니다.

### Warranty

정상적인 사용 조건에서 제품을 운용했음에도 제품이 제대로 동작하지 않을 경우, 한화비전㈜에서 무료로 수리해 드립니다. 보증 기간은 3년이며, 다음과 같은 상황은 보증에서 제외됩니다.

- 시스템 운용과 관련 없는 프로그램을 실행하여 시스템이 잘못된 동작을 한 경우
- 시간 경과에 따른 제품의 변화 또는 사용 중 자연적 마모에 의한 이상

❖ 제품의 외관, 사양등은 성능 개선을 위해 예고 없이 변경될 수 있습니다.

# 개요

---

## 목차

---

**개요** 4 구성품 확인하기

3

**설치 및 연결** 6 설치하기

6







**부록** 12 제품 규격  
12 외관도

12

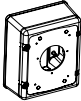
# 개요

## 구성품 확인하기

다음의 구성품이 모두 포함되어 있는지 확인하세요.

외관	품명	수량
	INSTALLATION BOX	1
	INSTALL BRACKET	1
	GASKET (SBP-300WM1/MMW1용)	1
	GASKET (SBP-300WM/MMW용)	1
	RUBBER HOUSING	1
	BRACKET ADAPTOR	1

외관	품명	수량
	MOUNT CAP	5
	MOUNT CAP fastener	1
	M10 x L22 SCREW (INSTALL BRACKET 고정용)	4
	M8 x L20 SCREW (Housing 고정용)	4
	M3 x L6 SCREW (BRACKET ADAPTOR 및 MEDIA CONVERT 고정용)	4
	M10 x L12 WRENCH BOLT (SBP-300WM/WMW 고정용)	4
	M10 x L20 WRENCH BOLT (SBP-300WM1/WMW1 고정용)	4
	M4 x L8 SCREW (MEDIA CONVERT 고정용)	2

# 설치 및 연결

## 설치하기

1. DOOR의 LOCKING LEVER를 밀어서, HOUSING과 DOOR를 분리합니다.

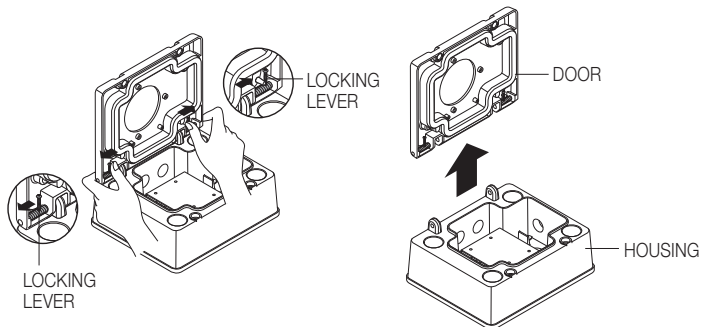

2. 스크류 4개를 분리하여, BRACKET ADAPTOR를 분리합니다.  
그리고, 사용하지 않는 배관홀은 첨부된 마운트캡으로 잠금처리합니다.  
마운트캡 고정시에 마운트캡 패스너를 사용하여 주시기 바랍니다.

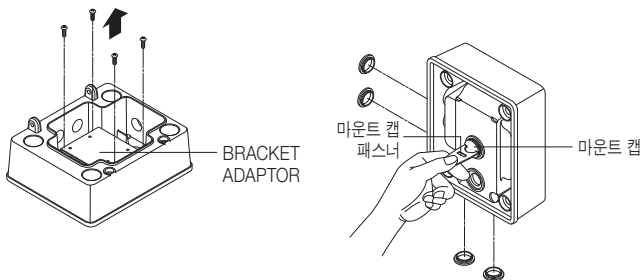

3. GASKET의 배면에 양면테이프를 제거한 후, DOOR에 부착합니다.  
DOOR에 Wall mount를 M10 SCREW 4개를 이용하여 체결합니다.  
< Wall Mount가 GASKET에 고르게 압착될 수 있도록, SCREW 4개소를 반복적으로 조여 주세요. >

- SBP-300WM1/SBP-300MMW1 Wall Mount 적용시 (M10 x L20 SCREW 적용)

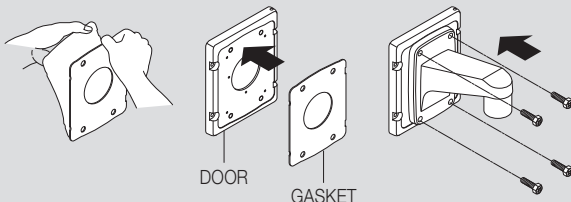

- SBP-300WM/SBP-300MMW Wall Mount 적용시  
(하단 이미지와 같이 Wall Mount가 GASKET의 홈 안쪽으로 고르게 조립되도록  
해주세요.) (M10 x L12 SCREW 적용)

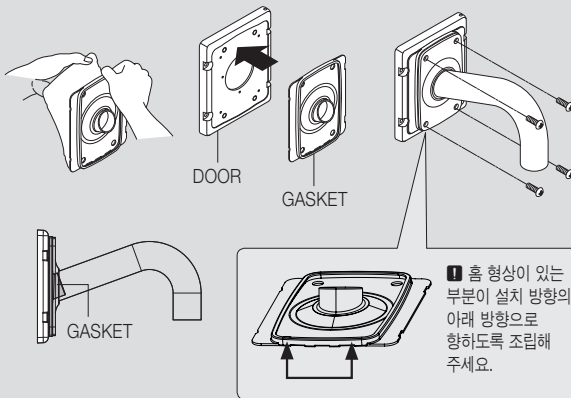

# 설치 및 연결

4. INSTALL BRACKET을 벽면이나 Corner MOUNT (SBP-300KM/SBP-300KMW), Pole Mount (SBP-300PM/SBP-300PMW)에 M10 screw로 체결합니다.  
반드시, 약세서리에 포함된 하기 이미지의 SCREW 4개를 이용하세요.

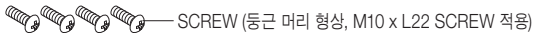

- 벽면에 설치시

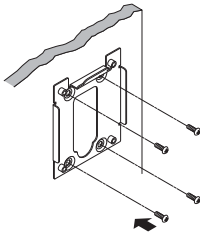

- Corner Mount

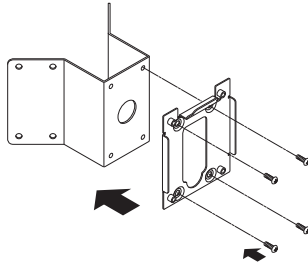

- Pole Mount

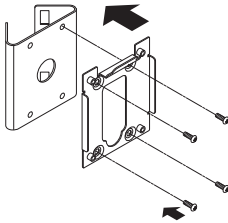



5. HOUSING을 INSTALL BRACKET에 그림과 같이 얹어 놓습니다.

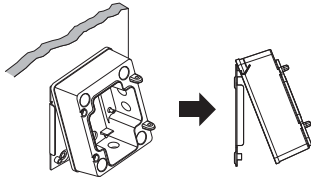

- 벽면에 설치할 경우에는 RUBBER HOUSING을 그림과 같이 체결하여 주세요.  
단, 본 RUBBER는 방수 기능이 아닌, 외관의 들뜸을 감추기 위한 DECORATION(장식용)입니다.  
따라서, 벽면에서 배관으로 연결되지 않고, 케이블 단독으로 인입될 경우에는 본체로 케이블이 인입되는 입구에는 방수처리를 완벽히 해 주셔야 합니다.  
그렇지 않으면 방수에 문제가 발생합니다.

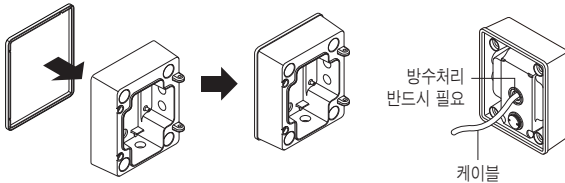

6. HOUSING을 M8 나사 4개로 "4번" 설치 과정의 INSTALL BRACKET에 고정합니다.

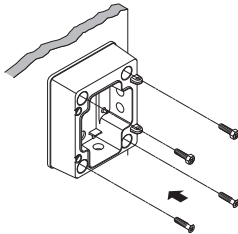

# 설치 및 연결

7. 파이프를 이용하여 외부 케이블을 본체 내부로 집어 넣습니다.  
파이프의 나사산 부분에는 Teflon tape로 감아서 방수에 문제가 생기지 않도록 조치해 주세요.  
(케이블 인입구에는 방수에 문제없도록 조치해 주세요.)

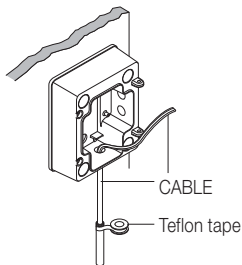

8. BRACKET ADAPTOR 부품을 이용하여, 전원 아답터와 MEDIA CONVERT 등을 설치하여 외부 CABLE과 연결합니다.

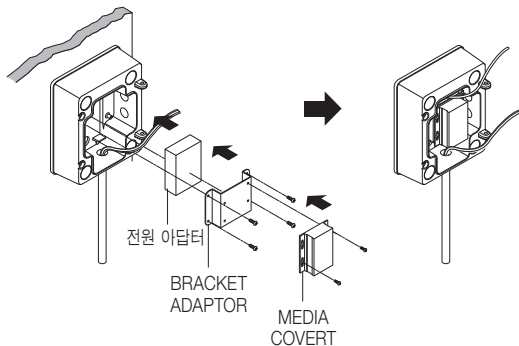

9. CABLE을 DOOR와 WALL MOUNT를 통해서 외부로 빼어 낸 후, DOOR를 HOUSING에 체결합니다.  
(LOCKING LEVER를 원위치로 원복한 후에, 힌지가 HOUSING에 정확히 고정되어 있는지 확인해주세요.)

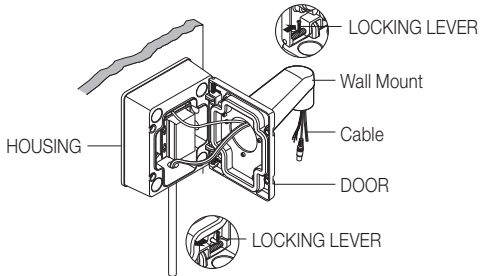

10. 육각렌치를 이용하여, DOOR를 HOUSING에 고정합니다. (하기 이미지와 같이 DOOR를 손으로 눌러주면서 스크류를 고정해 주세요. 그리고, SCREW를 반복적으로 회전하여, DOOR가 HOUSING에 단단히 압착되도록 해주세요.)

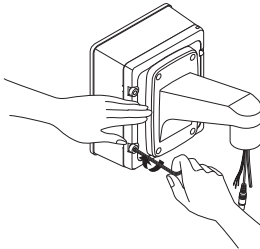

# 부록

## 제품 규격

항목	규격
외형 크기(mm)	W185.0 x D221.0 x H94.3 (mm)
무게	3.4kg
재질	STEEL, ALUMINUM, SILICON

## 외관도

단위: mm (인치)

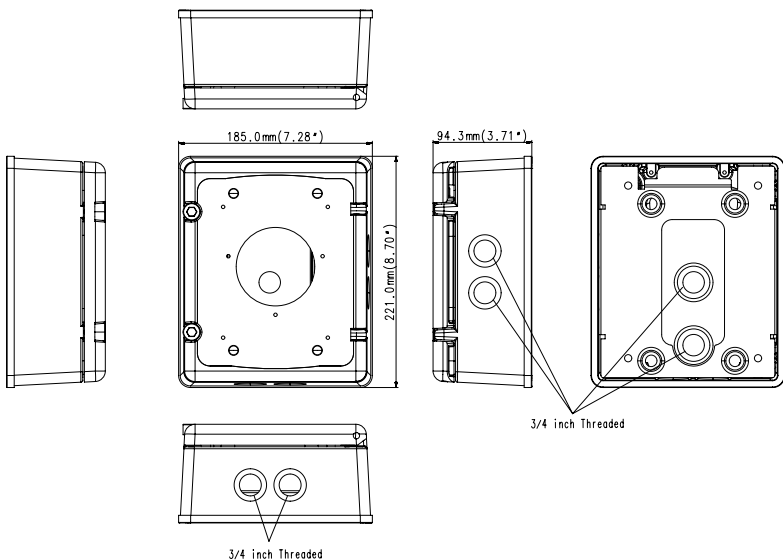

# 품질보증서

제 품 명	INSTALLATION BOX	보증 기간
모 델 명	SBP-300NB/SBP-300NBW	구 입 후 3년 (소모품 제외)
구 입 일 자	년 월 일	
보 증 기 간	년 월 일 까지	

고객 주소	성 명	
	연락처	
판매점 주소(상호)	성 명	
	연락처	

※ 제품 판매시 공란의 내용을 필히 기입하여 주십시오.

## ◀ 서비스를 받으실 때 ▶

제품 고장으로 판단되더라도 서비스를 요청하기 전에 반드시 사용설명서를 한 번 더 읽어 주십시오. 사용방법을 알지 못해서 고장으로 판단하실 수 있으므로 사용설명서의 취급법과 주의사항 등을 보시면 간단히 해결되는 경우가 있습니다.

서비스를 요청하시는 방법은?

요청하실 때는 고장상태를 정확히 알려 주십시오.

이때 보증서를 함께 제시하시면 보증서에 기재된 내용에 따라 유상, 무상수리의 구분이 됩니다.

## 한화비전(주)

경기도 성남시 분당구 판교로 319번길 6(삼평동 701)

영 업 TEL 070-7147-8771~9 A/S 및 기술문의 1588-5772

부산영업소 TEL 051-796-3216

대구영업소 TEL 053-742-3098

광주영업소 TEL 062-941-9559

대전영업소 TEL 042-489-9840

아래 사항에 따른 고장은 보증에서 제외되며, 수리 불가 혹은 유상 처리 될 수 있습니다.

- 1) 설치자 과실, 사용자 취급 부주의에 의한 고장
- 2) 정격 전원 외의 전원 연결 시
- 3) 사용자 임의로 분해, 수리한 경우
- 4) 자연재해에 의한 고장 (낙뢰, 지진, 화재, 홍수, 해일 등)
- 5) 소모품 교체 및 추가 시(HDD/SSD, SD카드, 아답터, FAN 등)



**한화비전**

# INSTALLATION BOX

## User Manual

SBP-300NB (IVORY)  
SBP-300NBW (WHITE)



# INSTALLATION BOX

## User Manual

---

### Copyright

©2019 Hanuwa Vision Co., Ltd. All rights reserved.

### Trademark

Each of trademarks herein is registered. The name of this product and other trademarks mentioned in this manual are the registered trademark of their respective company.

### Restriction

Copyright of this document is reserved. Under no circumstances, this document shall be reproduced, distributed or changed, partially or wholly, without formal authorization.

### Disclaimer

Hanuwa Vision makes the best to verify the integrity and correctness of the contents in this document, but no formal guarantee shall be provided. Use of this document and the subsequent results shall be entirely on the user's own responsibility. Hanuwa Vision reserves the right to change the contents of this document without prior notice.

❖ Design and specifications are subject to change without prior notice.



## CONTENTS

---

**OVERVIEW** 4 What's Included

3

**INSTALLATION & CONNECTION** 6 Installation







6

**APPENDIX** 12 Specification  
12 Product Overview

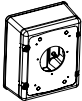
12

## WHAT'S INCLUDED

Please check if your camera and accessories are all included in the product package.

Appearance	Item Name	Quantity
	INSTALLATION BOX	1
	INSTALL BRACKET	1
	Gasket (for SBP-300WM1/WMW1)	1
	Gasket (for SBP-300WM/WMW)	1
	RUBBER HOUSING	1
	BRACKET ADAPTOR	1

Appearance	Item Name	Quantity
	MOUNT CAP	5
	MOUNT CAP fastener	1
	M10 x L22 screw (to attach the install bracket)	4
	M8 x L20 screw (to attach the housing)	4
	M3 x L6 screw (to attach the bracket adaptor and media convert)	4
	M10 x L12 wrench bolt (to attach SBP-300WM/WMW)	4
	M10 x L20 wrench bolt (to attach SBP-300WM1/WMW1)	4
	M4 x L8 screw (to attach the media convert)	2

# installation & connection

## INSTALLATION

1. Push the locking lever on the door to separate the housing and door.

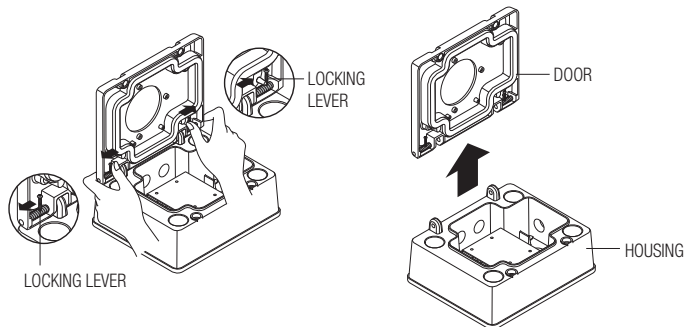

2. Undo the four screws to separate the bracket adaptor.  
Lock the unused piping hole with the attached mount cap.  
Use a mount cap fastener to attach the mount cap.

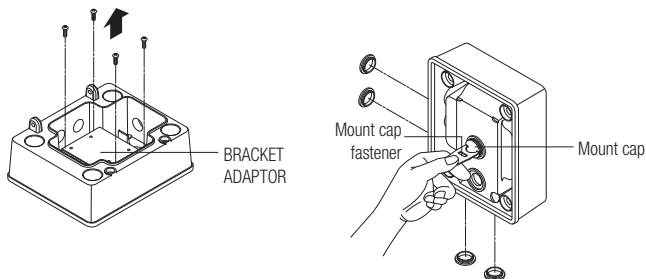

3. Remove the double-sided tap on the rear side of the gasket and affix it to the door. Attach the wall mount to the door using the four M10 screws.  
< Tighten each of the four screws a little at a time so that the wall mount is evenly pressed to the gasket. >

- Use of SBP-300WM1/SBP-300WMW1 wall mount (with M10 x L20 screws)

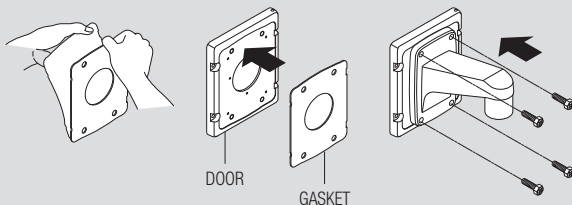

- Use of SBP-300WM/SBP-300WMW wall mount (evenly securing the wall mount inside the gasket groove as shown in the image below.) (with M10 x L12 screws)

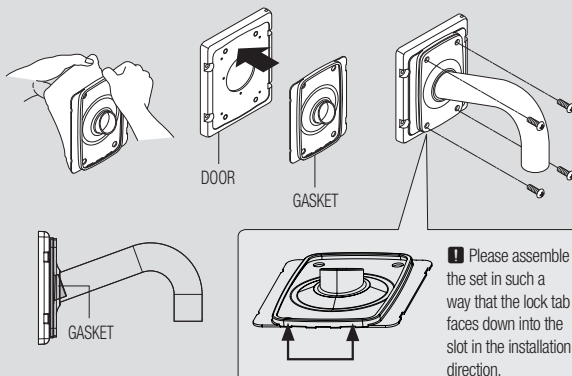

# installation & connection

---

4. Attach the install bracket to the wall, corner mount (SBP-300KM/SBP-300KMW) or pole mount (SBP-300PM/SBP-300PMW) using the M10 screws.

Only use the 4 screws included in the accessories as shown in the image below.



- Installation on the wall

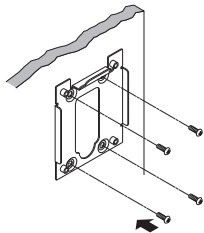

- Corner Mount

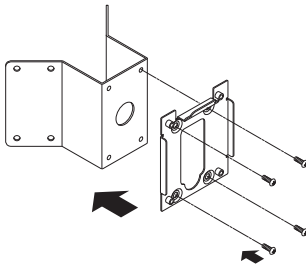

- Pole Mount

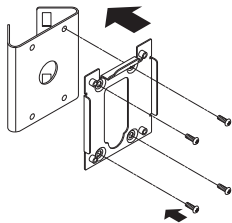

5. Place the housing on the install bracket as shown in the image.

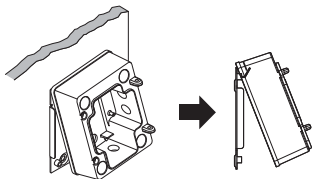

- To install it on the wall, attach the rubber housing as shown in the figure. The rubber is not waterproof. It is decorative only, serving to hide a gap. Therefore, if the cable is inserted into the main body separately and not through the duct on the wall, the insertion point of the cable must be completely waterproof. If this is not done, any water leaks may cause problems.

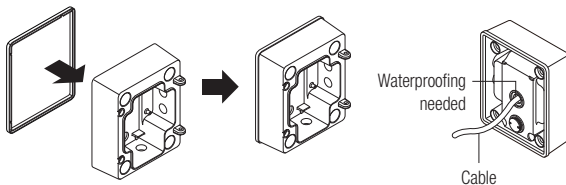

6. Secure the housing to the install bracket using 4 M8 screws in the same ways as "No. 4" in the installation procedure.

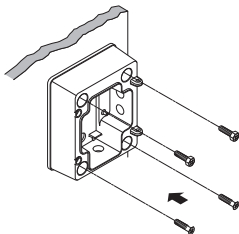

# installation & connection

---

7. Insert the external cable into the main body using a pipe.  
Wrap the thread of the pipe screw with Teflon tape to protect against water leakage problems.  
(Make sure that water leaks will not cause a problem at the cable insertion point.)

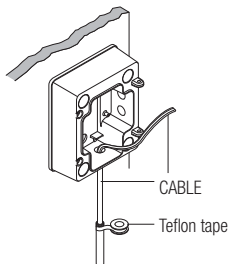

8. Install the power adaptor and media convert using the bracket adaptor, and connect the external cable.

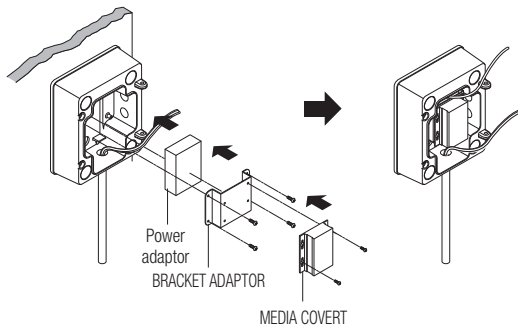



9. Pull the cable out through the door and wall mount and mount the door on the housing.  
(Return the locking lever to its original position and check that the hinge is properly attached to the housing.)

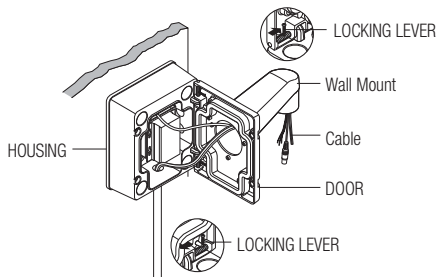

10. Fasten the door to the housing using a hexagonal wrench. (Tighten the screws while pressing the door with your hand as shown in the image below. Then tighten each of the screws a little at a time to make sure that the door is tightly pressed to the housing.)

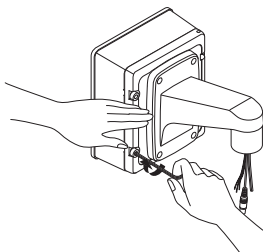

## SPECIFICATION

Items	Description
Dimensions (mm)	W185.0 x D221.0 x H94.3 (mm)
Weight	3.4kg
Material	STEEL, ALUMINUM, SILICON

## PRODUCT OVERVIEW

Unit : mm (inch)

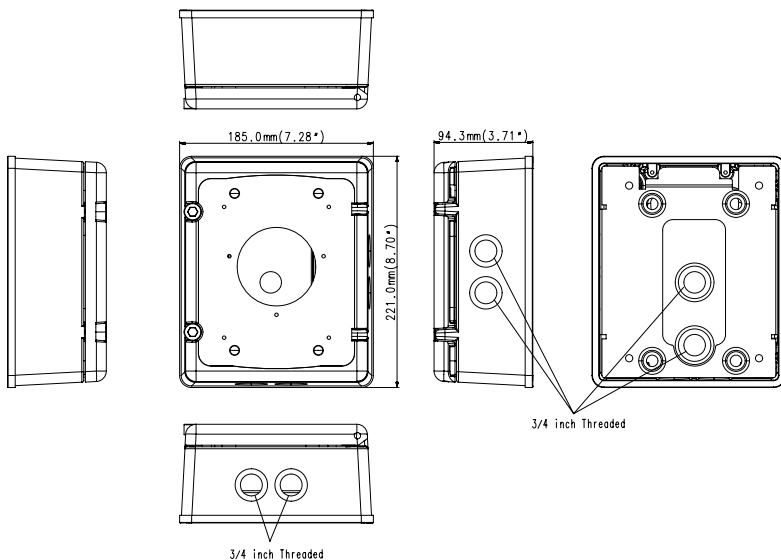



# **BOÎTIER D'INSTALLATION**

## Manuel d'utilisation

SBP-300NB (IVORY)  
SBP-300NBW (WHITE)



# Boîtier D'installation

## Manuel d'utilisation

---

### Droits d'auteur

©2019 Hanuwa Vision Co., Ltd. Tous droits réservés.

### Marque commerciale

Chaque marque déposée ci-dessus est enregistrée. Les noms de ce produit et d'autres marques de commerce mentionnées dans ce manuel sont les marques déposées de leurs sociétés respectives.

### Restriction

Le droit d'auteur de ce document est réservé. En aucun cas ce document ne doit être reproduit, distribué ou modifié, partiellement ou entièrement, sans l'autorisation formelle.

### Clause de non responsabilité

Hanuwa Vision fait de son mieux pour vérifier l'intégrité et l'exactitude des contenus de ce document, mais aucune garantie formelle ne sera fournie à cet effet. L'utilisation de ce document et les résultats subséquents seront entièrement de la responsabilité de l'utilisateur.

Hanuwa Vision se réserve le droit de modifier les contenus de ce document sans avis préalable.

❖ La conception et les caractéristiques techniques sont susceptibles d'être modifiées sans préavis.

# présentation

---

## SOMMAIRE

---

**PRÉSENTATION** 4 Contenu

3

**INSTALLATION ET CONNEXION** 6 Installation

6







**ANNEXES** 12 Spécifications  
12 Vue du Produit



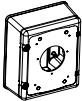





12

# présentation

## CONTENU

Veillez vérifier si votre caméra et l'ensemble de ses accessoires sont contenus dans l'emballage du produit.

Apparence	Nom de l'élément	Quantité
	BOÎTIER D'INSTALLATION	1
	INSTALLER LE JOINT	1
	Joint (pour SBP-300WM1/WMW1)	1
	Joint (pour SBP-300WM/WMW)	1
	BOÎTIER EN CAOUTCHOUC	1
	ADAPTATEUR DE JOINT	1

Apparence	Nom de l'élément	Quantité
	BOUCHON	5
	PIÈCE DE FIXATION	1
	Vis M10 x L22 (pour fixer le support d'installation)	4
	Vis M8 x L20 (pour fixer le boîtier)	4
	Vis M3 x L6 (pour fixer l'adaptateur du support et le convertisseur de support)	4
	Boulon M10 x L12 (pour fixer le SBP-300WM/WMW)	4
	Boulon M10 x L20 (pour fixer le SBP-300WM1/WMW1)	4
	Vis M4 x L8 (pour fixer le convertisseur de support)	2



# installation et connexion

## INSTALLATION

1. Poussez le levier de verrouillage de la porte pour séparer le boîtier et la porte.

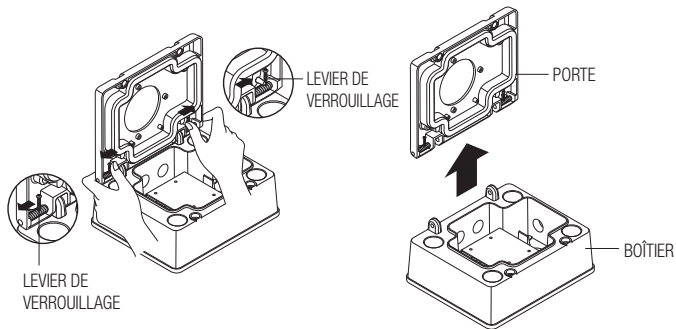

2. Desserrez les quatre vis pour séparer l'adaptateur du support.  
Verrouillez le trou de tuyauterie non utilisé avec le bouchon prévu à cet effet.  
Utilisez une pièce de fixation pour fixer le bouchon.

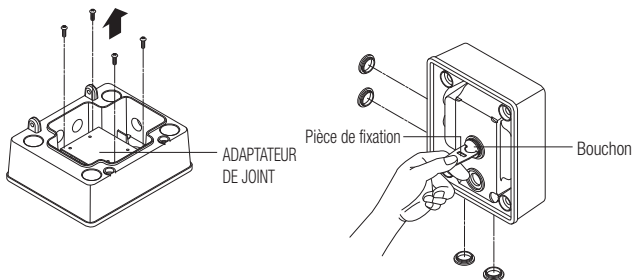

3. Retirez le robinet double-face de la face arrière du joint et fixez-le au niveau de la porte. Fixez le support mural à la porte en utilisant les quatre vis M10.

< Serrez chacune des quatre vis l'une après l'autre afin que le support mural soit uniformément appuyé contre le joint. >

- Utilisation du support mural SBP-300WM1/SBP-300WMW1 (avec les vis M10 x L20)

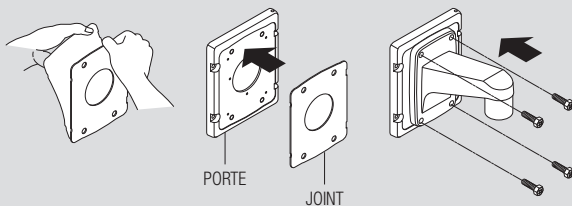

- Utilisation du support mural SBP-300WM/SBP-300WMW (pour fixer le support mural à l'intérieur de la rainure de joint comme indiqué dans l'image ci-dessous.) (avec les vis M10 x L12)

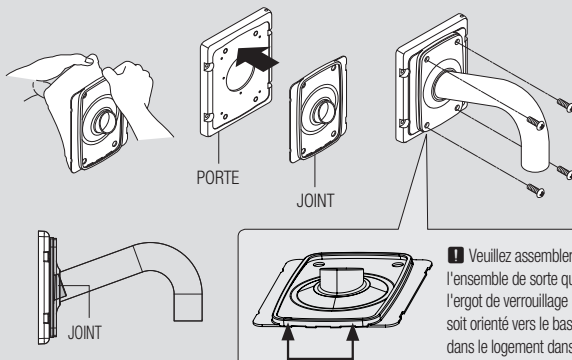

# installation et connexion

4. Fixez le support d'installation sur l'angle du mur (SBP-300KM/SBP-300KMW) ou sur un poteau (SBP-300PM/SBP-300PMW) avec des vis M10.

Utilisez uniquement les quatre vis fournies dans les accessoires comme indiqué dans l'image ci-dessous.



- Installation au mur

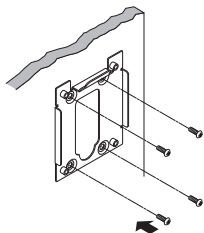

- Angle Du Mur

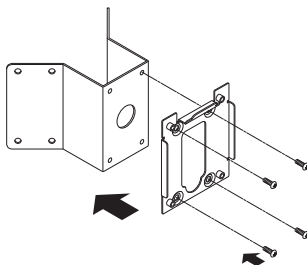

- Poteau

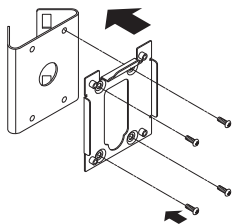

5. Placez le boîtier sur le support d'installation, comme indiqué dans l'image.

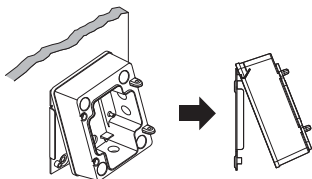

- Pour l'installer sur le mur, fixez le boîtier en caoutchouc comme indiqué sur l'image. Le caoutchouc n'est pas étanche. Il est utilisé à titre décoratif, et permet de masquer l'espace. Par conséquent, si le câble est inséré dans le corps principal séparément et non à travers le conduit de la paroi, le point d'insertion du câble doit être totalement étanche. Si cela n'est pas fait, les fuites d'eau poseront problème.

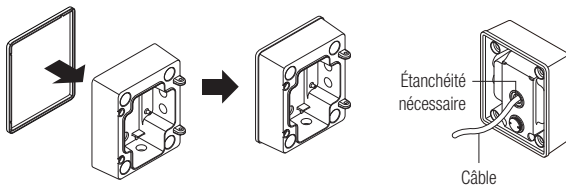

6. Fixez le boîtier sur le support d'installation en utilisant quatre vis M8 de la même manière qu'au point « n° 4 » de la procédure d'installation.

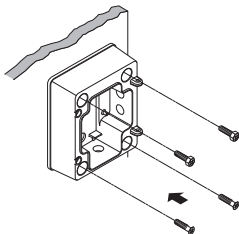

# installation et connexion

- Insérez le câble externe dans le corps principal à l'aide d'un tuyau.  
Enroulez le fil du tuyau avec du ruban de marque Téflon afin de le protéger des problèmes de fuite d'eau.  
(Assurez-vous que les fuites d'eau ne poseront aucun problème au niveau du point d'insertion du câble.)

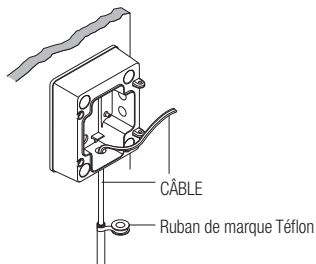

- Installez l'adaptateur d'alimentation et le convertisseur de support à l'aide de l'adaptateur du support, puis branchez le câble externe.

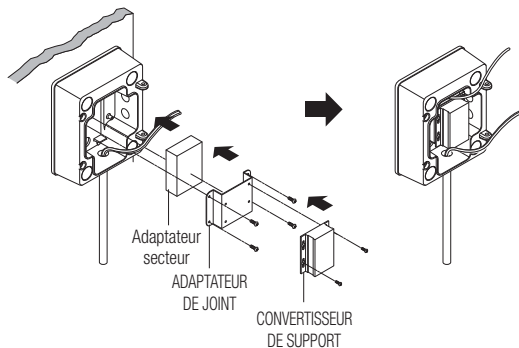

9. Tirez le câble à travers la porte et le support mural, puis montez la porte sur le boîtier.  
(Remettez le levier de verrouillage à sa position d'origine et vérifiez que la charnière est correctement fixée au boîtier.)

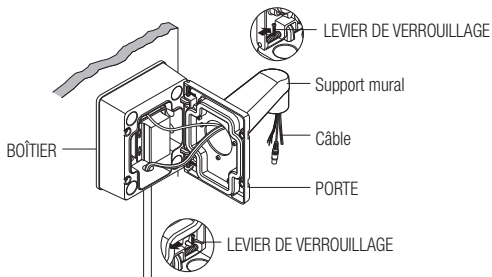

10. Fixez la porte au boîtier à l'aide d'une clé hexagonale. (Serrez les vis tout en appuyant la porte avec votre main comme indiqué sur l'image ci-dessous. Puis serrez chacune des vis l'une après l'autre afin de vous assurer que la porte est hermétiquement appuyée contre le boîtier.)

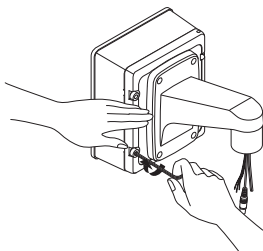

## SPÉCIFICATIONS

Éléments	Description
Dimensions (mm)	185 mm (l) x 221 mm (P) x 94,3 mm (H)
Poids	3,4kg
Matériau	ACIER, ALUMINIUM, SILICONE

## VUE DU PRODUIT

Unité : mm (pouce)

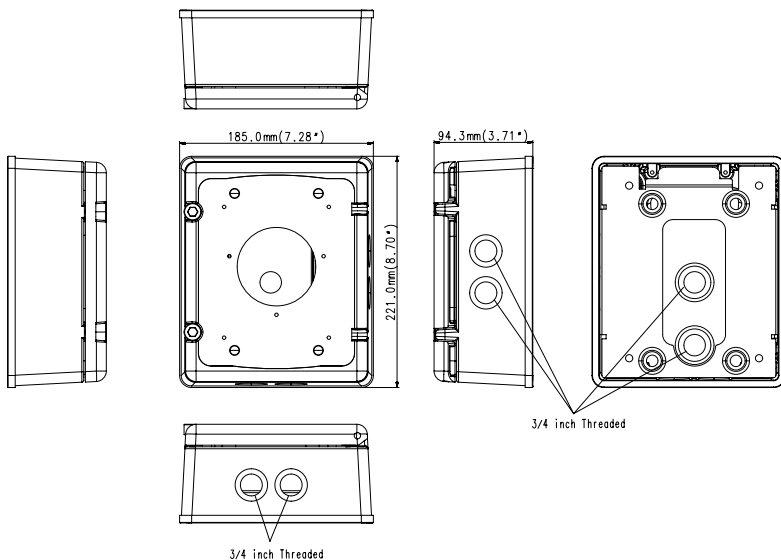





# **INSTALLATIONSBOX**

## Benutzerhandbuch

SBP-300NB (IVORY)  
SBP-300NBW (WHITE)



# INSTALLATIONSBOX

## Benutzerhandbuch

---

### Copyright

©2019 Hanuwa Vision Co., Ltd. Alle Rechte vorbehalten.

### Handelsmarke

Alle Marken in diesem Dokument sind registriert. Der Name dieses Produkts und andere Marken in diesem Handbuch gelten als eingetragenes Warenzeichen der jeweiligen Unternehmen.

### Richtlinien

Alle Rechte dieses Dokuments sind vorbehalten. Unter keinen Umständen darf dieses Dokument reproduziert, verteilt oder ganz oder teilweise ohne ausdrückliche Genehmigung modifiziert werden.

### Haftungsausschluss

Hanuwa Vision ist bemüht, die Korrektheit Integrität des Inhaltes dieses Dokuments sicherzustellen, wird aber keine Garantie zur Verfügung gestellt. Die Verwendung dieses Dokuments und der darauffolgenden Ergebnisse erfolgt auf alleinige Verantwortung des Benutzers. Hanuwa Vision behält sich das Recht vor, Änderungen der Dokumenteninhalte ohne vorherige Ankündigung vorzunehmen.

❖ Design und technische Daten können ohne vorherige Ankündigung geändert werden.

# Übersicht

---

## INHALTE

---

**ÜBERSICHT** 4 Lieferumfang

3

**INSTALLATION & VERBINDUNG** 6 Installation

6







**ANHANG** 12 Spezifikationen  
12 Produktansicht



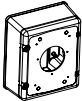





12

# übersicht

## LIEFERUMFANG

Überprüfen Sie bitte, ob in der Produktverpackung die Kamera und alle Zubehörteile enthalten sind.

Produktdesign	Bezeichnung	Menge
	INSTALLATIONSBOX	1
	HALTERUNG INSTALLIEREN	1
	Dichtung (für SBP-300WM1/WMW1)	1
	Dichtung (für SBP-300WM/WMW)	1
	GUMMIGEHÄUSE	1
	KLAMMERADAPTER	1

Produktdesign	Bezeichnung	Menge
	GEWINDEDECKEL	5
	GEWINDEDECKELVERSCHLUSS	1
	M10 x L22 Schraube (zur Befestigung der installierten Halterung)	4
	M8 x L20 Schraube (zur Befestigung des Gehäuses)	4
	M3 x L6 Schraube (zur Befestigung des Halterung-Zwischenstücks und des Medienumwandlers)	4
	M10 x L12 Schraube (zur Befestigung des SBP-300WM/WMW)	4
	M10 x L20 Schraube (zur Befestigung des SBP-300WM1/WMW1)	4
	M4 x L8 Schraube (zur Befestigung des Medienumwandlers)	2

# installation & verbindung

## INSTALLATION

1. Den Feststellungshebel an die Tür drücken, um Gehäuse und Tür zu trennen.

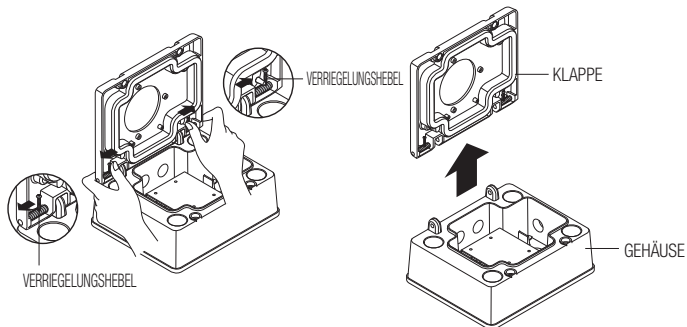

2. Die vier Schrauben abdrehen, um das Halterung-Zwischenstück zu trennen.  
Das nicht genutzte Loch des Rohres mit dem befestigten Gewindedeckel verschließen.  
Zur Befestigung des Gewindedeckels ein Befestigungselement des Gewindedeckels verwenden.

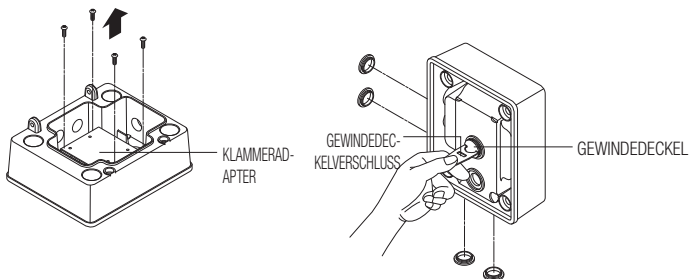

3. Das zweiseitige Klebeband auf der Rückseite der Dichtung entfernen und an der Tür anbringen. Die Wandbefestigung an der Tür anbringen, dabei die vier M10-Schrauben verwenden.  
**<Jede der vier Schrauben nach und nach festziehen, damit die Wandbefestigung gleichmäßig gegen die Dichtung drückt.>**

- Verwendung der SBP-300WM1/SBP-300WMW1 Wandbefestigung (mit M10 x L20 Schrauben)

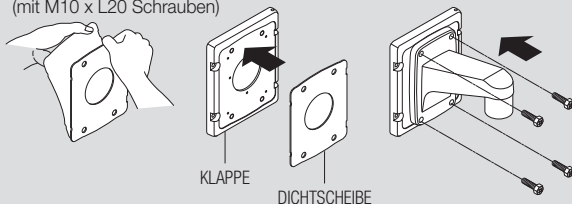

- Verwendung der SBP-300WM/SBP-300WMW Wandbefestigung (die Wandbefestigung, wie unten im Bild angezeigt, gleichmäßig innen in der Dichtungsnut befestigen.) (mit M10 x L12 Schrauben)

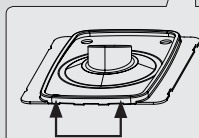
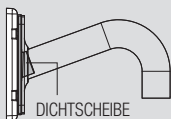
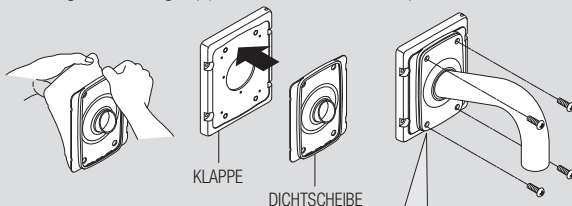

**!** Bauen Sie den Gerätesatz bitte so zusammen, dass der Sicherungsriegel nach unten in den Schlitz und in die Installationsrichtung zeigt.

# installation & verbindung

4. Die Installationshalterung an der Wand befestigen, Eckbefestigung (SBP-300KM/SBP-300KMW) oder Mastansatz (SBP-300PM/SBP-300PMW) unter Verwendung der M10-Schrauben.  
Nur die 4 Schrauben verwenden, die mit dem Zubehör, siehe Abbildung unten, mitgeliefert wurden.



- Wandinstallation

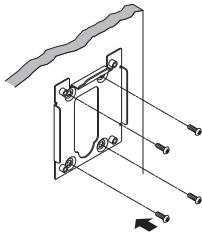

- Eckhalterung

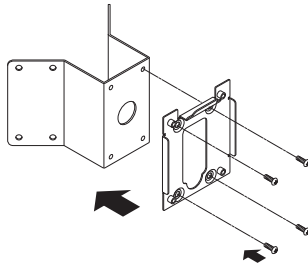

- Masthalterung

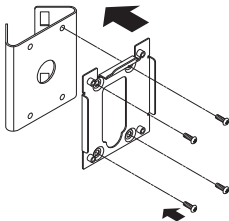



5. Das Gehäuse auf die Installationshalterung platzieren, siehe Bild unten.

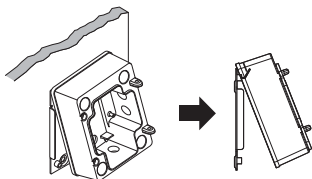

- Zum Montieren an der Wand das Gummigehäuse, wie im Bild dargestellt, befestigen. Der Gummi ist nicht wasserdicht. Er dient nur als Dekoration zum Verbergen einer Spalte. Wird das Kabel getrennt in das Hauptgehäuse und nicht durch den Kanal an der Wand eingeführt, muss die Einlassöffnung des Kabels vollständig wasserdicht sein. Wird dies nicht beachtet, kann es bei jedem Wasserleck Probleme geben.

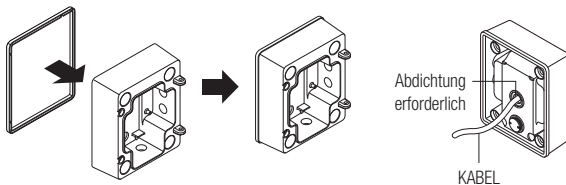

6. Das Gehäuse an der Installationshalterung befestigen, dabei die 4 M8-Schrauben genauso wie bei "Nr. 4" des Installationsverfahrens verwenden.

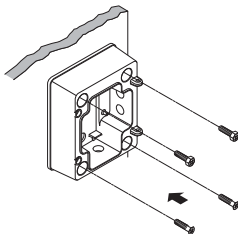

# installation & verbindung

---

7. Das externe Kabel in das Hauptgehäuse unter Verwendung eines Rohres einschieben.  
Das Gewinde der Rohrschraube mit einem Teflon-Band umwickeln, zum Schutz vor Problemen mit Wasser und Leckage.  
(Versichern Sie sich, dass es bei der Einlassöffnung des Kabels zu keinen Problemen wegen des Wasserlecks kommt.)

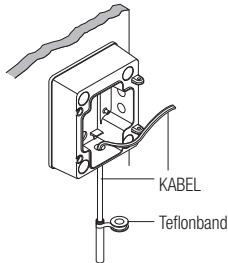

8. Installieren Sie den Netzteil und den Medienumwandler unter Verwendung des Halterungs-Zwischenstücks und verbinden Sie das externe Kabel.

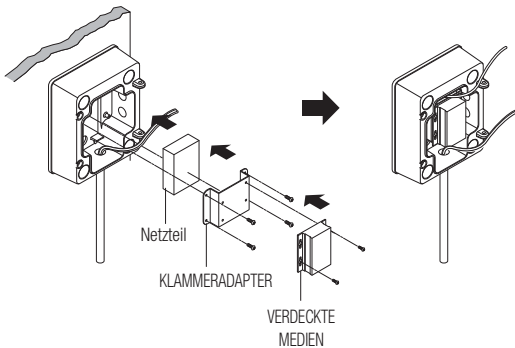

9. Ziehen Sie das Kabel durch die Tür und die Wandbefestigung und montieren Sie die Tür an das Gehäuse.  
(Stellen Sie den Feststellungshebel in die ursprüngliche Position zurück und prüfen Sie, ob das Scharnier richtig am Gehäuse befestigt ist.)

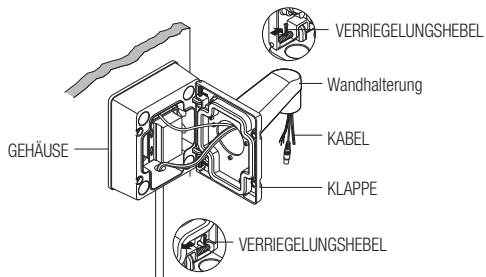

10. Befestigen Sie die Tür am Gehäuse befestigen und verwenden Sie dafür einen Sechskantschlüssel.  
(Die Schrauben festziehen, wobei die Tür mit der Hand gedrückt wird, siehe Abbildung unten.  
Dann ziehen Sie jede der Schrauben nach und nach fest, um sicherzustellen, dass die Tür fest gegen das Gehäuse drückt.)

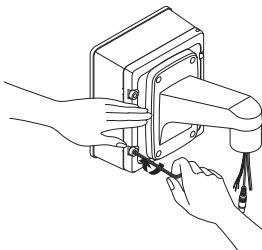

## SPEZIFIKATIONEN

Elemente	Beschreibung
Maße (mm)	W185,0 x D221,0 x H94,3 (mm)
Gewicht	3.4kg
Material	STAHL, ALUMINUM, SILIZIUM

## PRODUKTANSICHT

Einheit: mm (inch)

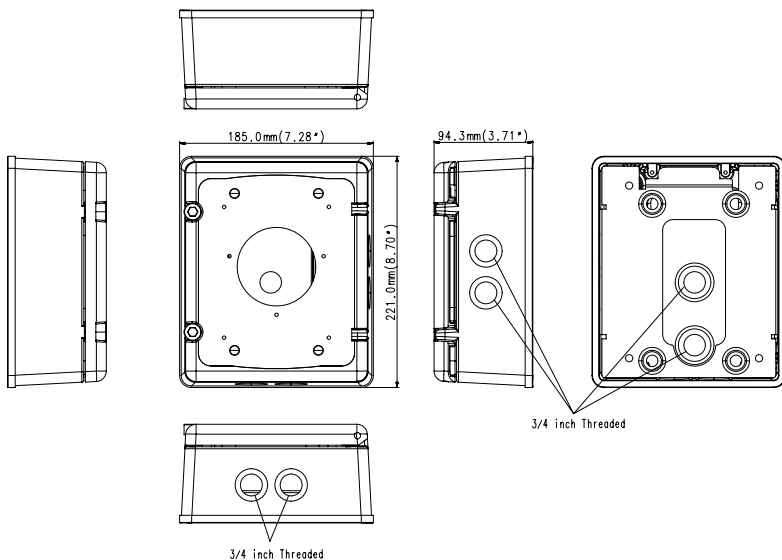



# **CONFEZIONE D'INSTALLAZIONE**

Manuale utente

SBP-300NB (IVORY)  
SBP-300NBW (WHITE)



# CONFEZIONE D'INSTALLAZIONE

## Manuale utente

---

### Copyright

©2019 Hanwha Vision Co., Ltd. Tutti i diritti riservati.

### Marchio

Ogni marchio di fabbrica qui presente è registrato. Il nome di questo prodotto e altri marchi di fabbrica menzionati in questo manuale sono marchi registrati della rispettiva azienda.

### Limitazioni

Il Copyright in questo documento è riservato. Questo documento non può essere copiato, distribuito o modificato, parzialmente o completamente, senza un'autorizzazione formale.

### Declinazione di responsabilità

Hanwha Vision fa del suo meglio per verificare l'integrità e la correttezza dei contenuti del presente documento, ma non fornisce nessuna garanzia formale. L'uso di questo documento e i risultati che ne derivano ricadono interamente sotto la responsabilità dell'utente. Hanwha Vision si riserva il diritto di modificare i contenuti di questo documento senza preavviso.

❖ Il progetto e le specifiche sono soggetti a modifiche senza preavviso.

## INDICE

---

**INTRODUZIONE** 4 Accessori forniti

3

**INSTALLAZIONE E COLLEGAMENTO** 6 Installazione

6

**APPENDICE** 12 Specifica  
12 Panoramica del Prodotto







12



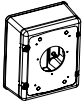





# introduzione

## ACCESSORI FORNITI

Verificare che nella confezione siano contenuti la videocamera e tutti gli accessori.

Aspetto	Articolo	Quantità
	CONFEZIONE D'INSTALLAZIONE	1
	INSTALLARE SUPPORTO	1
	Guarnizione (per SBP-300WM1/WMW1)	1
	Guarnizione (per SBP-300WM/WMW)	1
	UNITÀ DI GOMMA	1
	ADATTATORE DEL SUPPORTO	1

Aspetto	Articolo	Quantità
	TAPPO DI MONTAGGIO	5
	Stringitore del TAPPO DI MONTAGGIO	1
	Vite M10 x L22 (per il montaggio del supporto d'installazione)	4
	Vite M8 x L20 (per il montaggio dell'unità)	4
	Vite M3 x L6 (per il montaggio dell'adattatore del supporto al convertitore multimediale)	4
	Vite a testa esagonale M10 x L12 (per il montaggio di SBP-300WM1/WMW1)	4
	Vite a testa esagonale M10 x L20 (per il montaggio di SBP-300WM1/WMW1)	4
	Vite M3 x L8 (per il montaggio del convertitore multimediale)	2

# installazione e collegamento

## INSTALLAZIONE

1. Spingere la leva di bloccaggio sulla porta per separare la porta dall'unità principale.

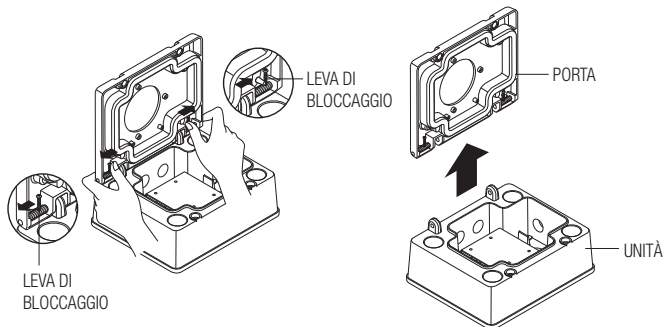

2. Allentare le quattro viti per separare l'adattatore del supporto.  
Bloccare il foro inutilizzato del condotto con il tappo di montaggio fornito insieme all'unità.  
Utilizzare un dispositivo di fissaggio per fissare il tappo di montaggio.

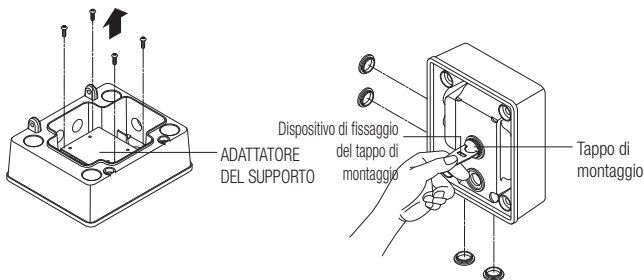

3. Rimuovere il tappo biadesivo che si trova sul retro del supporto e fissarlo sulla porta.  
Attaccare il supporto a muro sulla porta utilizzando le quattro viti M10.  
< Stringere ognuna delle quattro viti un po' alla volta di modo che il supporto a muro sia correttamente fissato sulla guarnizione. >

- Utilizzare il supporto a muro SBP-300WM1/SBP-300WMW1 (con le viti M10 x L20)

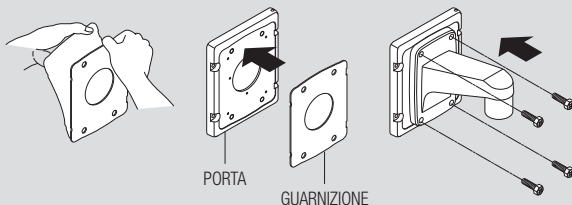

- Utilizzare il supporto a muro SBP-300WM/SBP-300WMW (fissando adeguatamente il supporto a muro all'interno della scanalatura della guarnizione come mostrato nell'immagine qui sotto). (con le viti M10 x L12)

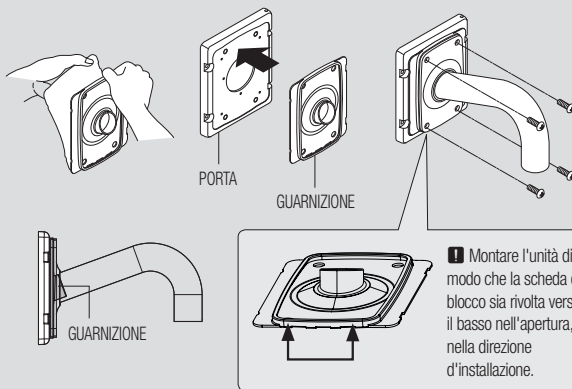

# installazione e collegamento

4. Fissare il supporto d'installazione sul muro, montaggio ad angolo (SBP-300KM/SBP-300KMW) o montaggio ad asse (SBP-300PM/SBP-300PMW) utilizzando le viti M10. Utilizzare esclusivamente le 4 viti fornite negli accessori, come mostrato nell'immagine qui sotto.



- Installazione a muro

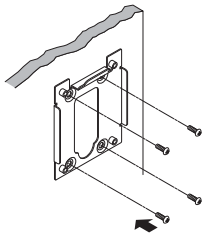

- Montaggio ad angolo

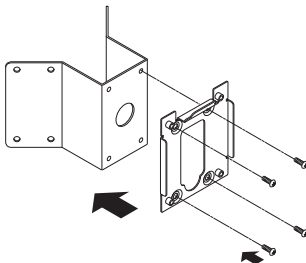

- Montaggio su asse

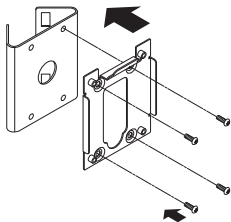

5. Posizionare l'unità sul supporto d'installazione come mostrato nell'immagine.

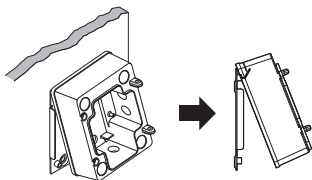

- Per installarla sul muro, fissare l'unità di gomma come mostrato nella figura. La gomma non è impermeabile. Ha soltanto uno scopo decorativo e serve per coprire un vuoto. Di conseguenza, se si inserisce separatamente un cavo all'interno dell'unità principale e non attraverso il condotto sul muro, il punto d'inserimento del cavo deve essere completamente impermeabile. Altrimenti, qualunque gocciolamento di acqua potrebbe causare problemi.

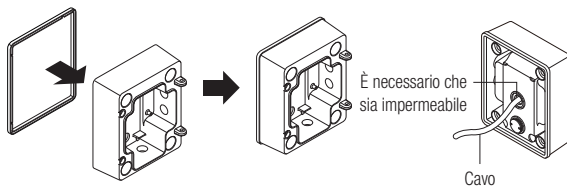

6. Assicurare l'unità al supporto d'installazione utilizzando le 4 viti M8 come descritto nel passaggio "N.4" della procedura d'installazione.

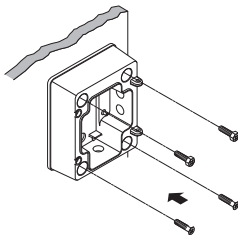

# installazione e collegamento

7. Inserire il cavo esterno nell'unità principale utilizzando un condotto.  
Avvolgere la filettatura della vite del condotto con del nastro di Teflon per proteggerlo da eventuali gocciolamenti di acqua.  
(Assicurarsi che i gocciolamenti di acqua non causino problemi nel punto d'inserimento del cavo).

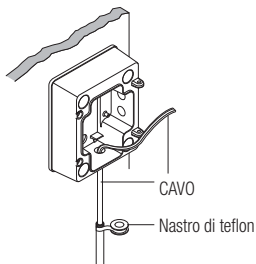

8. Installare l'adattatore di corrente e il convertitore multimediale utilizzando l'adattatore di supporto. Quindi, collegare il cavo esterno.

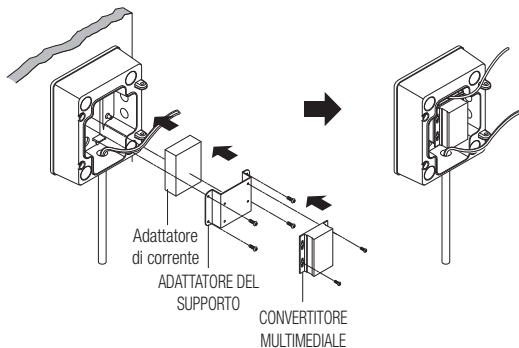

9. Tirare il cavo attraverso la porta e l'installazione a muro e montare la porta sull'unità.  
(Riportare la leva di bloccaggio alla posizione originale e controllare che il cardine sia correttamente fissato all'unità).

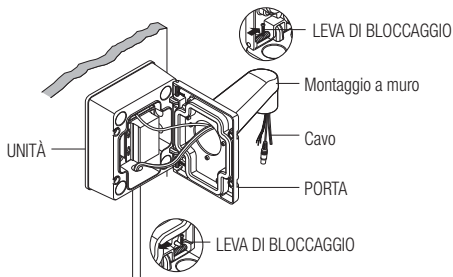

10. Stringere la porta all'unità utilizzando una chiave esagonale. (Stringere le viti facendo pressione sulla porta con la mano come mostrato nell'immagine qui sotto. Quindi, stringere ognuna delle viti un po' alla volta, assicurandosi che la porta sia premuta contro l'unità).

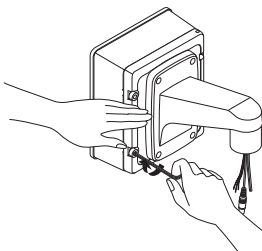



## SPECIFICA

Elementi	Descrizione
Dimensioni (mm)	L185.0 x P221.0 x A94.3 (mm)
Peso	3.4kg
Materiale	ACCIAIO, ALLUMINIO, SILICONE

## PANORAMICA DEL PRODOTTO

Unità: mm (pollici)

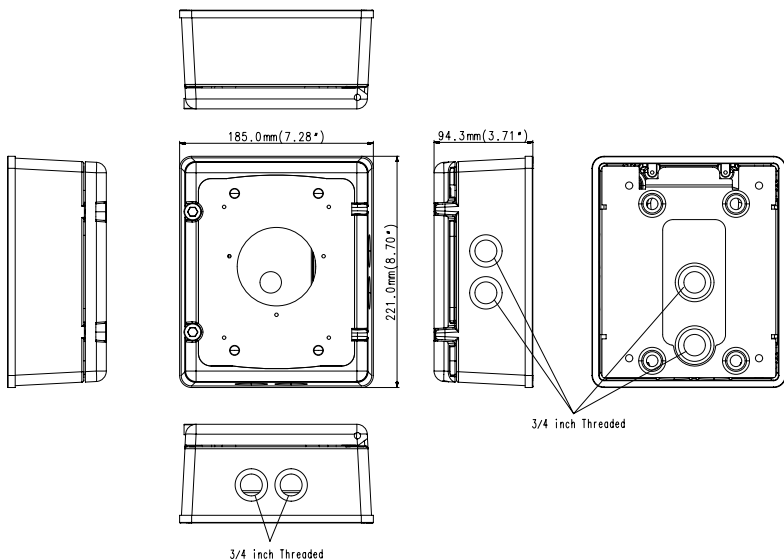



# CAJA DE INSTALACIÓN

## Manual del usuario

SBP-300NB (IVORY)  
SBP-300NBW (WHITE)



# CAJA DE INSTALACIÓN

## Manual del usuario

---

### Copyright

©2019 Hanuwa Vision Co., Ltd. Reservados todos los derechos.

### Marca comercial

Todas las marcas aquí mencionadas están registradas. El nombre de este producto y otras marcas mencionadas en este manual son marcas registradas de sus respectivas compañías.

### Restricción

Reservados los derechos de autor de este documento. Este documento no se deberá reproducir, distribuir ni cambiar, de modo total o parcial, bajo ninguna circunstancia, sin autorización formal.

### Renuncia

Hanuwa Vision hace lo máximo por verificar la integridad y exactitud del contenido de este documento, pero no se proporciona ninguna garantía formal. El uso de este documento y los resultados posteriores será total responsabilidad del propio usuario. Hanuwa Vision se reserva el derecho a cambiar el contenido de este documento sin aviso previo.

❖ El diseño y las especificaciones están sujetos a cambio sin aviso.

## ÍNDICE GENERAL







---



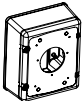





<b>DESCRIPCIÓN</b>	4	Componentes
3		
<b>INSTALACIÓN Y CONEXIÓN</b>	6	Instalación
6		
<b>APÉNDICE</b>	12	Especificaciones
	12	Vista del Producto
12		

# descripción

## COMPONENTES

Compruebe si la cámara y los accesorios se incluyen en el paquete del producto.

Aspecto	Nombre de elemento	Cantidad
	CAJA DE INSTALACIÓN	1
	SOPORTE DE INSTALACIÓN	1
	Junta (para SBP-300WM1/WMW1)	1
	Junta (para SBP-300WM/WMW)	1
	CUBIERTA DE CAUCHO	1
	ADAPTADOR DE SOPORTE	1

Aspecto	Nombre de elemento	Cantidad
	TAPA de MONTAJE	5
	Cierre de la TAPA de MONTAJE	1
	Tornillo M10 x L22 (para fijar el soporte de instalación)	4
	Tornillo M8 x L20 (para fijar la cubierta)	4
	Tornillo M3 x L6 (para conectar el adaptador del soporte y el convertidor de medios)	4
	Perno de llave inglesa M10 x L12 (para fijar SBP-300WM/WMW)	4
	Perno de llave inglesa M10 x L20 (para fijar SBP-300WM1/WMW1)	4
	Tornillo M4 x L8 (para fijar el convertidor de medios)	2

# instalación y conexión

## INSTALACIÓN

1. Empujar la palanca de bloqueo de la puerta para separar la carcasa y la puerta.

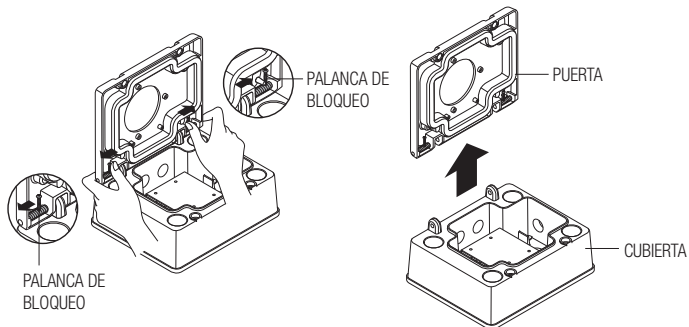

2. Aflojar los cuatro tornillos para separar el adaptador de soporte.  
Bloquear el agujero de la tubería sin usar mediante la tapa de montaje incluida.  
Utilizar un cierre de tapa de montaje para colocar la tapa de montaje.

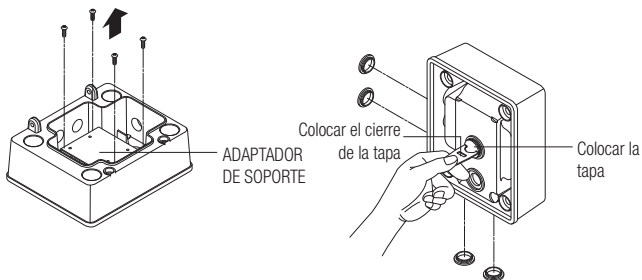



3. Retirar la llave de doble cara de la parte posterior de la junta y fijarla en la puerta.  
Fijar el montaje de pared a la puerta con los cuatro tornillos M10.  
< **Apretar los cuatro tornillos cada vez un poco, para que el montaje de pared quede apretado por igual a la junta.** >

- Utilizar el montaje de pared SBP-300WM1/SBP-300WMW1 (con tornillos M10 x L20)

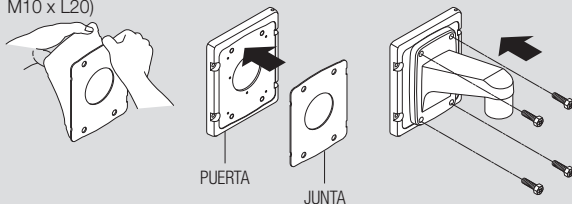

- Utilizar el montaje de pared SBP-300WM/SBP-300WMW (asegurar de manera uniforme el montaje de pared dentro de la ranura de la junta como se muestra en la imagen de abajo). (Con tornillos M10 x L12)

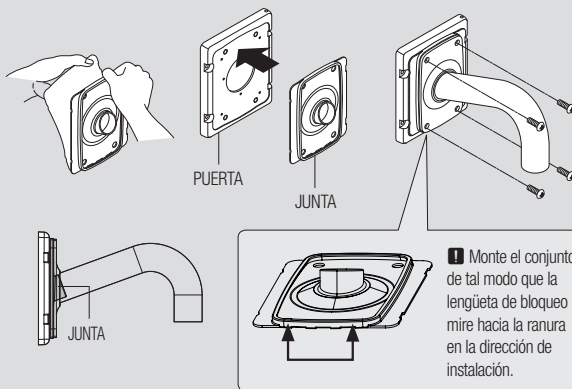

# instalación y conexión

4. Fije el soporte de instalación en la pared, el montaje de esquina (SBP-300KM/SBP-300KMW) o el montaje en poste (SBP-300PM/SBP-300PMW) con tornillos M10.

Utilice sólo los 4 tornillos incluidos en los accesorios como se muestra en la imagen de abajo.



- Instalación en la pared

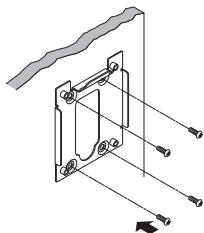

- Montaje de esquina

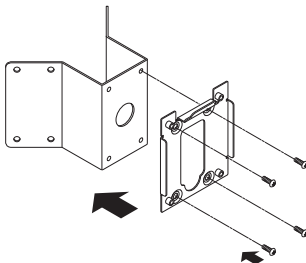

- Montaje en poste

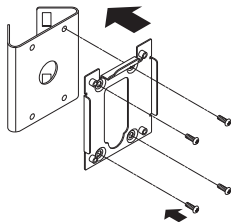

5. Colocar la cubierta en el soporte de instalación como se muestra en la imagen.

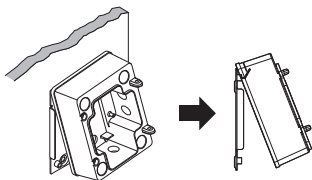

- Para instalarlo en la pared, fijar la cubierta de caucho como se muestra en la figura. El caucho no es impermeable. Es sólo decorativo y sirve para ocultar el hueco. Por lo tanto, si el cable se inserta en el cuerpo principal por separado y no a través del conducto de la pared, el punto de inserción del cable debe ser completamente impermeable. Si esto no se hace, cualquier fuga de agua podría ocasionar problemas.

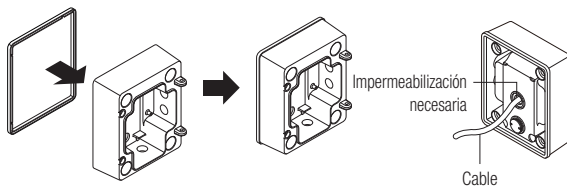

6. Asegurar la cubierta al soporte de instalación mediante 4 tornillos M8 de la misma forma que en el procedimiento de instalación "nº 4".

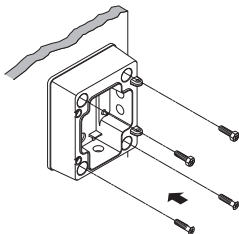

# instalación y conexión

7. Insertar el cable externo en el cuerpo principal mediante una tubería.  
Envolver la rosca del tornillo de tubo con cinta de teflón para proteger contra los problemas de fugas de agua.  
(Asegurarse de que las fugas de agua no van a causar un problema en el punto de inserción del cable).

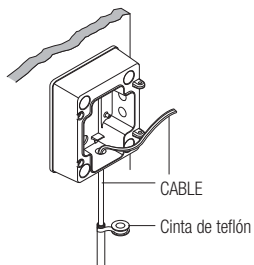

8. Instalar el adaptador de corriente y el convertidor de medios mediante un adaptador de soporte y conectar el cable externo.

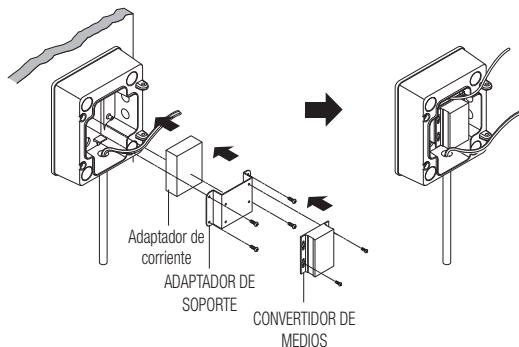

9. Sacar el cable a través de la puerta y del montaje en la pared y montar la puerta en la carcasa. (Colocar la palanca de bloqueo en su posición original y verificar que la bisagra está fijada correctamente a la carcasa).

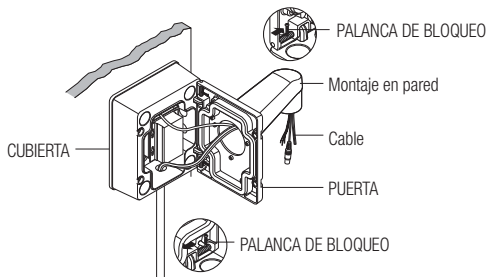

10. Fijar la puerta a la carcasa con una llave hexagonal. (Apretar los tornillos mientras presiona la puerta con la mano como se muestra en la imagen de abajo. A continuación, apretar cada uno de los tornillos un poco a la vez para asegurarse de que la puerta esté bien fijada a la carcasa).

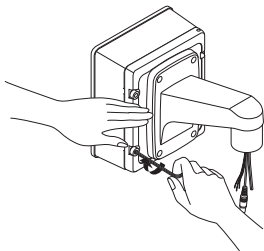

## ESPECIFICACIONES

Opciones	Descripción
Tamaño (mm)	Ancho 185,0 x Profundidad 221,0 x Altura 94,3 (mm)
Peso	3.4kg
Material	ACERO, ALUMINIO, SILICIO

## VISTA DEL PRODUCTO

Unidad : mm (pulg.)

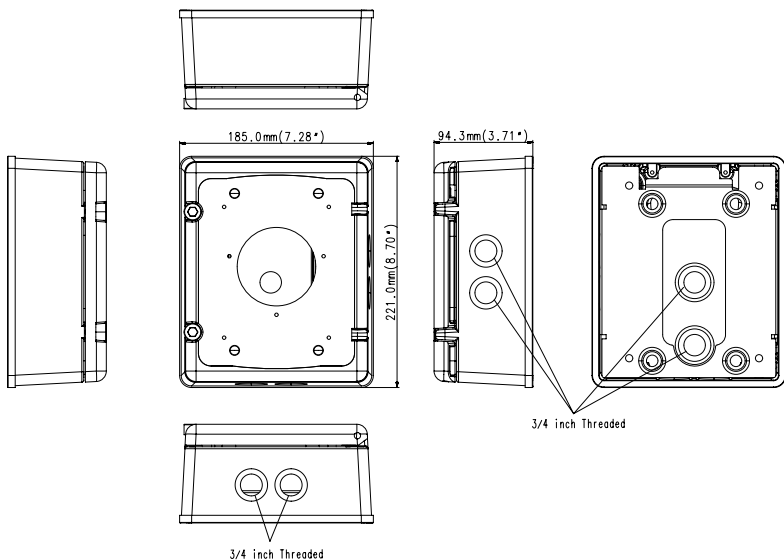



# **МОНТАЖНАЯ КОРОБКА**

## **Руководство пользователя**

SBP-300NB (IVORY)  
SBP-300NBW (WHITE)





# Монтажная Коробка

## Руководство пользователя

---

### Авторское право

©2019 Hanuha Vision Co., Ltd. Все права защищены.

### Все права защищены

Каждый из торговых знаков далее в документе является зарегистрированным. Название данного продукта и другие торговые знаки, упоминаемые в данном руководстве, являются зарегистрированными торговыми знаками соответствующих компаний.

### Ограничения

Данный документ защищен авторским правом. Данный документ ни при каких обстоятельствах не разрешается воспроизводить, распространять или изменять, полностью или частично, без документально подтвержденного разрешения.

### Отказ от ответственности

Компания Hanuha Vision тщательно проверяет достоверность и правильность содержимого данного документа, однако не несет официальной ответственности за представленную информацию. Пользователь несет полную личную ответственность за использование этого документа и за последующие результаты. Компания Hanuha Vision оставляет за собой право изменять содержание документа без предварительного уведомления.

❖ Конструкция и характеристики устройства могут быть изменены без предварительного уведомления.

## СОДЕРЖАНИЕ

---

**ОБЗОР** 4 Комплект Поставки

3

**УСТАНОВКА И ПОДКЛЮЧЕНИЕ** 6 Установка







6



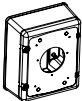





**ПРИЛОЖЕНИЕ** 12 Характеристики  
12 Вид Устройства

12

## КОМПЛЕКТ ПОСТАВКИ

Проверьте наличие всех принадлежностей в комплекте поставки камеры.

Внешний вид	Название элемента	Количество
	МОНТАЖНАЯ КОРОБКА	1
	УСТАНОВОЧНЫЙ КРОНШТЕЙН	1
	Прокладка (для SBP-300WM1/WMW1)	1
	Прокладка (для SBP-300WM/WMW)	1
	РЕЗИНОВЫЙ КОЖУХ	1
	АДАПТЕР КРОНШТЕЙНА	1

Внешний вид	Название элемента	Количество
	МОНТАЖНЫЙ КОЛПАЧОК	5
	Крепление МОНТАЖНОГО КОЛПАЧКА	1
	Винт М10 x 22 (для крепления установочного кронштейна)	4
	Винт М8 x 20 (для крепления кожуха)	4
	Винт М3 x 6 (для крепления адаптера кронштейна и медиа-конвертера)	4
	Болт М10 x 12 под гаечный ключ (для крепления SBP-300WM/WMW)	4
	Болт М10 x 20 под гаечный ключ (для крепления SBP-300WM1/WMW1)	4
	Винт М4 x 8 (для крепления медиа-конвертера)	2

# установка и подключение

## УСТАНОВКА

1. Нажмите на запорный рычажок на дверце и отделите кожух и дверцу.

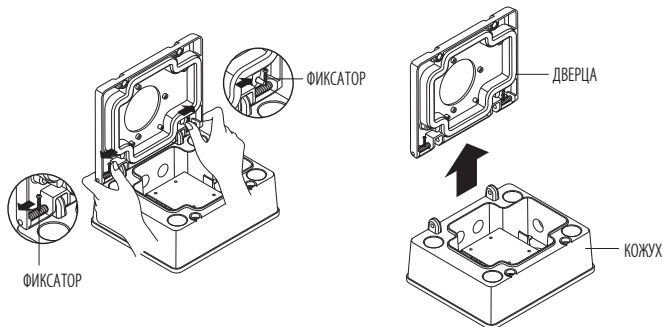

2. Отверните четыре винта для отделения адаптера кронштейна. Заглушите неиспользуемое отверстие для трубки прилагаемым колпачком. Для крепления колпачка используйте установочный фиксатор.

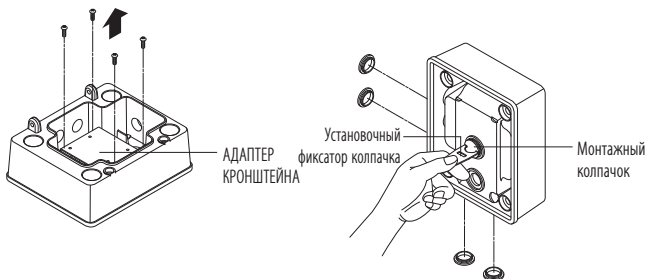

3. Удалите двустороннюю ленту с задней стороны прокладки и закрепите последнюю на дверце. С помощью четырех винтов M10 закрепите настенное крепление на дверце.

< Поочередно поемному затягивайте каждый из четырех винтов так, чтобы настенное крепление было равномерно прижато к прокладке. >

- Использование настенного крепления SBP-300WM1/SBP-300WMW1 (с винтами M10 x L20)

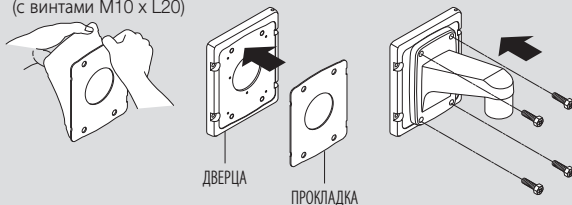

- Использование настенного крепления SBP-300WM/SBP-300WMW (ровно закрепите настенное крепление внутри канавки прокладки, как показано на рис. ниже). (с винтами M10 x L12)

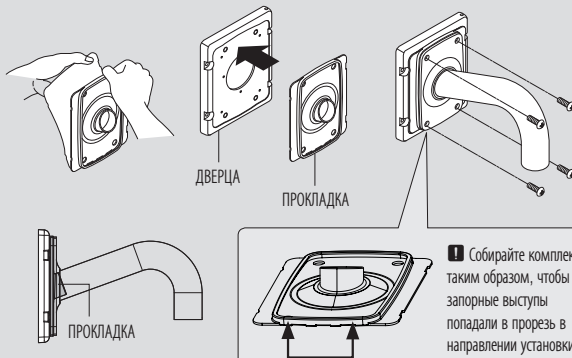

# установка и подключение

4. Закрепите установочный кронштейн на стене монтажным уголке (SBP-300KM/SBP-300KMW) или монтажной стойке (SBP-300PM/SBP-300PMW) винтами M10. Используйте только 4 винта, включенных в принадлежности, как показано на рисунке ниже.



- Установка на стене

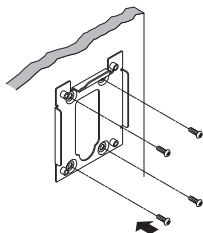

- Крепление на уголке

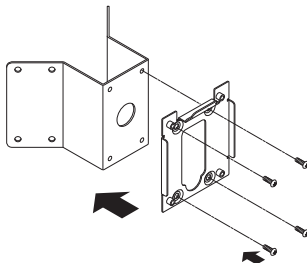

- Крепление на стойке

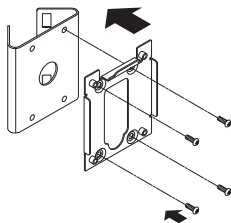

5. Наденьте кожух на установочный кронштейн, как показано на рисунке.

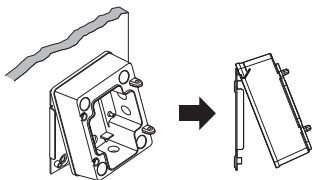

- Для установки на стене наденьте резиновый кожух, как показано на рисунке. Резина не обеспечивает водонепроницаемости. Это лишь декоративный элемент, скрывающий зазор. Поэтому если кабель вставляется в корпус отдельно, а не через лоток на стене, необходимо обеспечить водонепроницаемость места вставки кабеля. Если этого не сделать, любая протечка воды может вызвать проблемы.

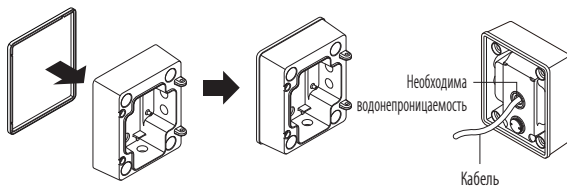

6. Закрепите кожух на установочном кронштейне 4 винтами М8 как описано в п. 4 процедуры установки.

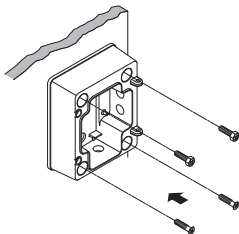



# установка и подключение

7. Вставьте внешний кабель в корпус, используя трубку.  
Для предотвращения проблем при попадании воды оберните резьбу трубчатого винта тефлоновой лентой.  
(Удостоверьтесь, что попадание воды не создаст проблем в месте вставки кабеля.)

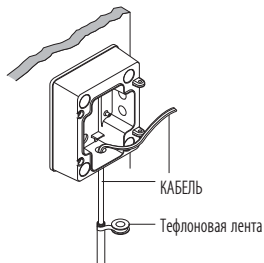

8. Используя адаптер кронштейна, установите адаптер питания и медиа-конвертер, подключите внешний кабель.

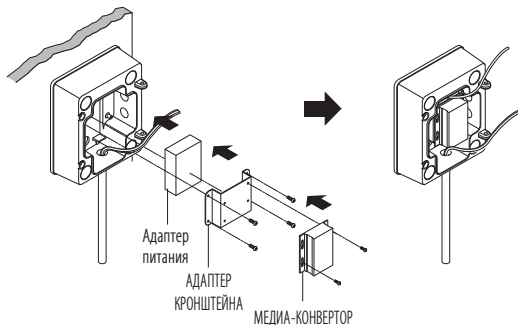

9. Вытяните кабель наружу через дверцу и настенное крепление, установите дверцу на кожу. (Верните запорный рычажок в начальное положение и убедитесь, что петля дверцы закреплена на коже надлежащим образом.)

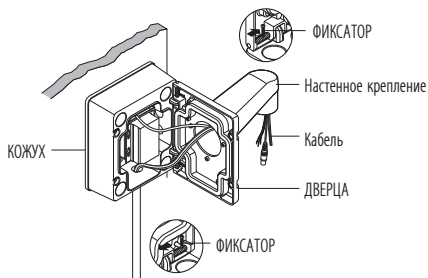

10. Закрепите дверцу на кожухе с помощью шестигранного гаечного ключа. (Затягивайте винты, прижимая дверцу рукой, как показано на рисунке ниже. Далее поочередно понемногу затягивайте каждый из винтов, убеждаясь, что дверца плотно прижимается к кожуху.)

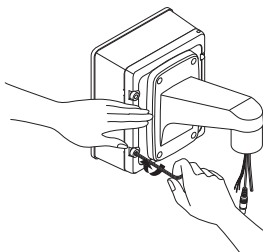

# приложение

## ХАРАКТЕРИСТИКИ

Элементы	Описание
Размеры (мм)	Ш 185,0 x Г 221,0 x В 94,3 (мм)
Вес	3.4кг
Материал	СТАЛЬ, АЛЮМИНИЙ, КРЕМНИЙ

## ВИД УСТРОЙСТВА

Единицы измерения: мм (дюймы)

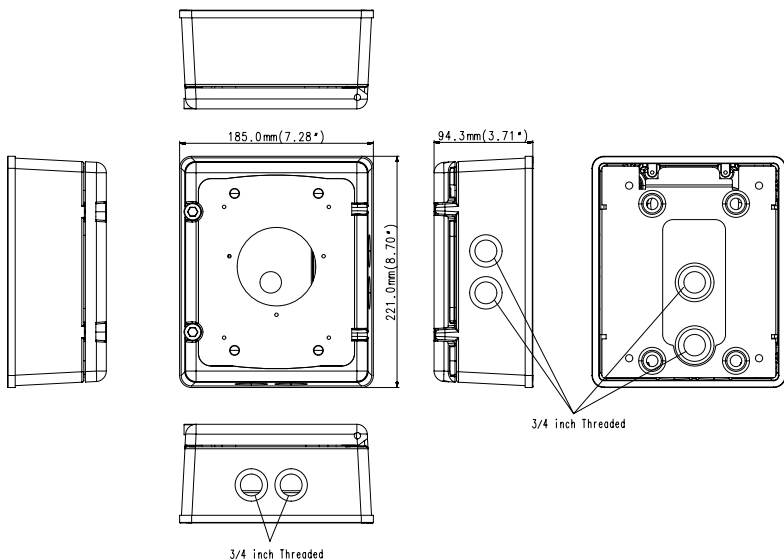



Подлежит использованию по назначению  
в нормальных условиях  
Срок службы : 7 лет.

# KURULUM KUTUSU

## Kullanım Kılavuzu

SBP-300NB (IVORY)  
SBP-300NBW (WHITE)



# Kurulum Kutusu

## Kullanım Kılavuzu

---

### Telif hakkı

©2019 Hanuha Vision Co., Ltd Tüm hakları saklıdır.

### Ticari marka

Burada belirtilen her bir ticari marka tescillidir. Bu kılavuzda bahsi geçen ürünün adı ve ticari markalar ilgili şirketin tescilli ticari markalarıdır.

### Kısıtlama

Bu dokümanın telif hakkı saklıdır. Resmî yetki olmadan, hiçbir koşul altında, bu doküman çoğaltılamaz, dağıtılamaz, kısmen veya tamamen değiştirilemez.

### Sorumluluk Reddi

Hanuha Vision bu belgedeki içeriklerin bütünlüğünü ve doğruluğunu sağlamak için mümkün olan tüm çabayı göstermekle birlikte resmî bir garanti verilmemektedir. Bu belgenin kullanımı ve bundan kaynaklanan tüm sonuçların sorumluluğu tamamen kullanıcıya aittir. Hanuha Vision bu belgenin içeriklerini önceden bildirim yapmadan değiştirme hakkını saklı tutar.

❖ Tasarım ve spesifikasyonlar önceden bildirim yapılmadan değiştirilebilir.

## İÇİNDEKİLER

---

**GENEL BAKIŞ** 4 Dahil Olanlar

3

**KURULUM VE BAĞLANTI** 6 Kurulum

6







**EK** 12 Teknik Özellikler  
12 Ürün Genel Bilgileri

12

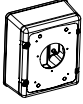







# genel bakış

## DAHİL OLANLAR

Kameranızın ve aksesuarlarınızın ürün ambalajında bulunup bulunmadığını lütfen kontrol edin.

Görünüm	Öge Adı	Adet
	KURULUM KUTUSU	1
	KURULUM DESTEĞİ	1
	Conta (SBP-300WM1/MMW1 için)	1
	Conta (SBP-300WM/MMW için)	1
	KAUÇUK MUHAFAZA	1
	DESTEK ADAPTÖRÜ	1



Görünüm	Öge Adı	Adet
	MONTAJ KAPAĞI	5
	MONTAJ KAPAĞI sabitleyici	1
	M10 x L22 vida (kurulum desteğini takmak için)	4
	M8 x L20 vida (muhafazayı takmak için)	4
	M3 x L6 vida (destek adaptörünü ve ortam dönüştürücüyü takmak için)	4
	M10 x L12 anahtar civatası (SBP-300WM/WMW'yi takmak için)	4
	M10 x L20 anahtar civatası (SBP-300WM1/WMW1'i takmak için)	4
	M4 x L8 vida (ortam dönüştürücüyü takmak için)	2

# kurulum ve bağlantı

## KURULUM

1. Muhafazayı ve kapağı ayırmak için kapağın üzerindeki kilitleme kolunu itin.

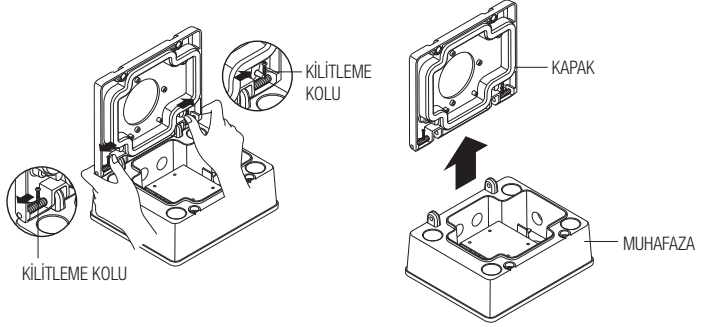

2. Destek adaptörünü ayırmak için dört vidayı çıkarın. Kullanılmayan boru deliğini takılı montaj kapağına kilitleyin. Montaj kapağını takmak için bir montaj kapağı sabitleyici kullanın.

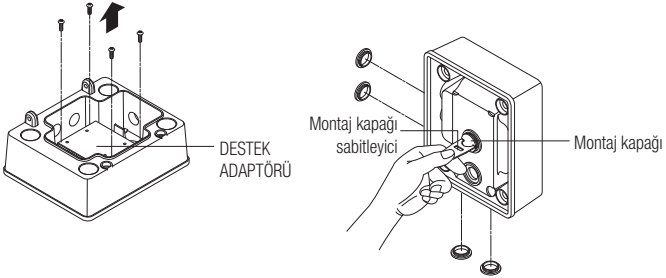

3. Contanın arka tarafındaki çift taraflı tapayı çıkarın ve kapağa takın.

Duvar montajını dört adet M10 vidayı kullanarak kapağa takın.

< Duvar montajı contaya eşit şekilde sıkıştırılıncaya kadar her defasında az miktarda olmak üzere dört vidanın her birini sıkın. >

- SBP-300WM1/SBP-300WMW1 duvar montajının kullanılması (M10 x L20 vidalarıyla)

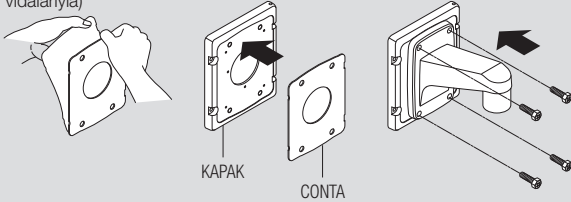

- SBP-300WM/SBP-300WMW duvar montajının kullanılması (aşağıdaki resimde gösterildiği gibi duvar montajının eşit şekilde conta yuvasına sabitlenmesi) (M10 x L12 vidalarıyla)

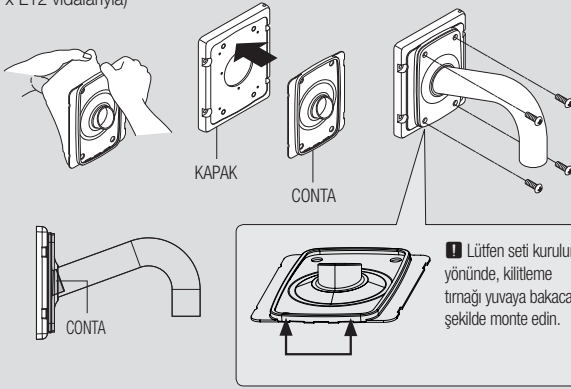

# kurulum ve bağlantı

4. Kurulum desteğini M10 vidalarını kullanarak duvara, köşe montajına (SBP-300KM/SBP-300KMW) veya direk montajına (SBP-300PM/SBP-300PMW) takın. Aşağıdaki resimde gösterildiği gibi yalnızca aksesuarlarda bulunan 4 vidayı kullanın.

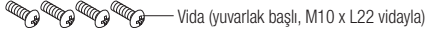

- Duvara kurulum

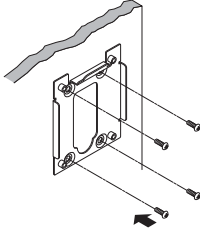

- Köşe Montajı

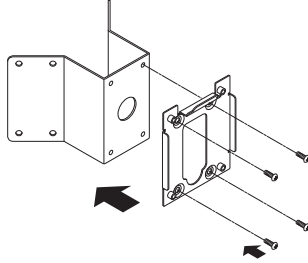

- Direk Montajı

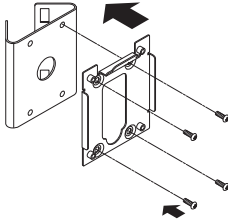

5. Muhafazayı resimde gösterildiği gibi kurulum desteğine yerleştirin.

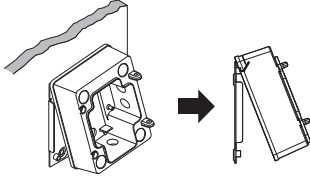

■ Duvara monte etmek için kauçuk muhafazayı resimde gösterildiği gibi takın.

Kauçuk su geçirmezlik özelliğine sahip değildir. Yalnızca dekoratif amaçlıdır ve bir boşluğu gizlemek için kullanılır. Bu nedenle, bir kablunun duvardaki kanala değil ana gövdeye ayrı olarak yerleştirilmesi durumunda, kablunun yerleştirme noktasının tamamen su geçirmez olması gerekir. Aksi halde, su sızıntısı sorunları oluşabilir.

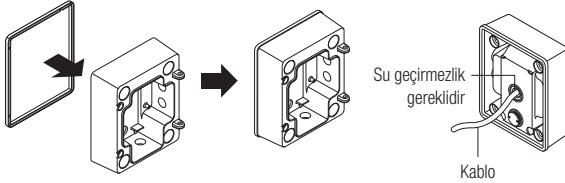

6. Kurulum prosedüründeki "No. 4" ile aynı şekilde 4 adet M8 vidayı kullanarak muhafazayı kurulum desteğine sabitleyin.

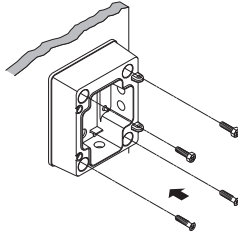

# kurulum ve bağlantı

7. Harici kabloyu bir boru kullanarak ana gövdeye yerleştirin.  
Su sızıntısı sorunlarını önlemek için boru vidasının dışlarına Teflon bant sarın.  
(Su sızıntılarının, kablo yerleştirme noktasında sorun oluşturmayacağından emin olun.)

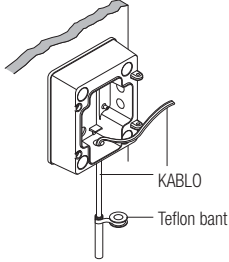

8. Güç adaptörünü ve ortam dönüştürücüyü destek adaptörünü kullanarak takın ve harici kabloyu bağlayın.

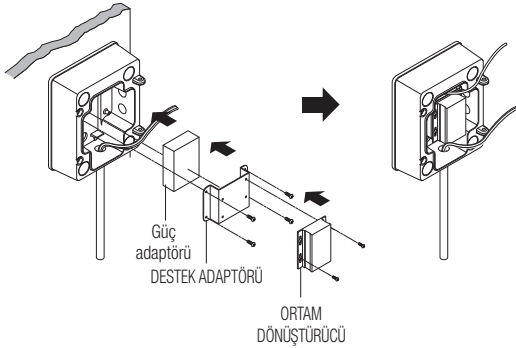

9. Kabloyu, kapağa ve duvar montajına doğru çekin ve kapağı muhafazanın üzerine monte edin. (Kilitleme kolunu orijinal konumuna getirin ve menteşenin muhafazaya düzgün şekilde takıldığından emin olun.)

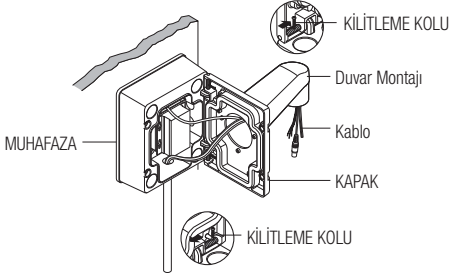

10. Kapağı altıgen anahtar kullanarak muhafazaya sabitleyin. (Aşağıdaki resimde gösterildiği gibi kapağı elinizle bastırarak vidaları sıkın. Ardından kapağın muhafazaya sıkıca bastırıldığından emin olmak için her defasında az miktarda olmak üzere vidaların her birini sıkın.)

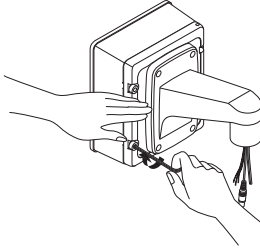

## TEKNİK ÖZELLİKLER

Parçalar	Açıklama
Boyutlar (mm)	G185,0 x D221,0 x Y94,3 (mm)
Ağırlık	3,4kg
Malzeme	ÇELİK, ALÜMİNYUM, SİLİKON

## ÜRÜN GENEL BİLGİLERİ

Birim : mm (inç)

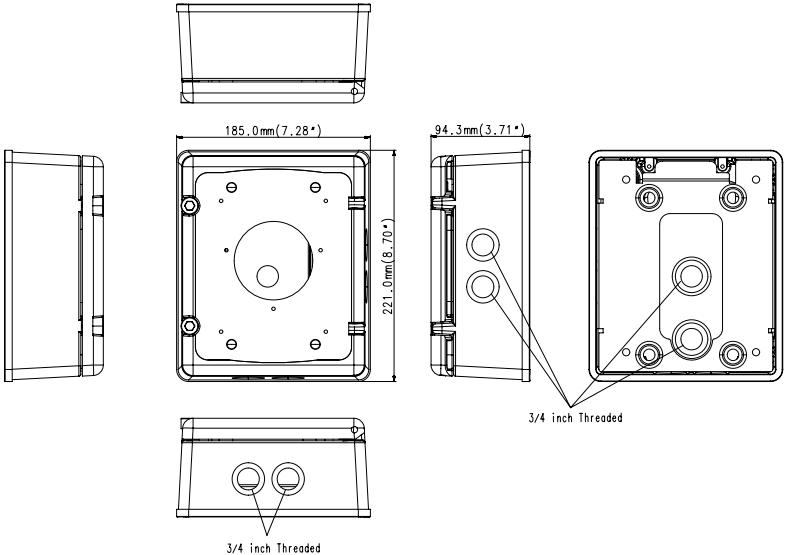





**Türkiye Distribütörü**

**EDS Elektronik Destek Sanayi ve Ticaret Ltd. Şti.**

Meclis Mah. Teraziler Cad. Hayran Sk. (Eskisi Kılıç Sk.) No: 4 Sancaktepe / İstanbul / Türkiye

Tel +90.216.313.25.15 Faks +90.216.528.45.98

**Koyuncu Elektronik Bilgi İşlem Sistemleri San. ve Dış. Tic. A.Ş.**

Emek Mah. Ordu Cad. No:18 Sancaktepe / İstanbul / Türkiye

Tel +90.216.528.88.88 Faks +90.216.313.18.18

**NFS Teknoloji ve Otomasyon Sistemleri San. Ve Tic. Ltd. Sti.**

Cumhuriyet Mah Şair M.Akif Ersoy Sk. No:36 Üsküdar / İstanbul / Türkiye

Tel +90.216.505.82.28 Faks +90.216.505.82.29

**Sensonet Teknoloji Elekt. ve Biliş. Hiz. San. ve Tic. Ltd. Şti.**

Ramazanoğlu Mah. Transtek Cad. No: 2 Pendik / İstanbul / Türkiye

Tel +90.216.999.49.49 Faks +90.212.381.61.02

**ENTES ELEKTRONİK CİHAZLAR İMALAT VE TİC. A.Ş.**

Dudullu Org.San.Bölg. 1. Cad. No:23 34776 Ümraniye - İstanbul / Türkiye

Tel +90.216.313.01.10 Faks +90.216.314.16.15

# SKRZYŃKA MONTAŻOWA

## Instrukcja obsługi

SBP-300NB (IVORY)  
SBP-300NBW (WHITE)



# SKRZYŃKA MONTAŻOWA

## Instrukcja obsługi

---

### **Prawa autorskie**

©2019 Hanuwa Vision Co., Ltd. Wszelkie prawa zastrzeżone.

### **Znaki towarowe**

Wszystkie znaki handlowe wymienione w niniejszym dokumencie są zastrzeżone. Nazwa niniejszego produktu i inne znaki handlowe wymienione w niniejszym podręczniku są zastrzeżonymi znakami handlowymi odpowiednich właścicieli.

### **Ograniczenia**

Prawa autorskie do tego dokumentu są zastrzeżone. Kopowanie, rozpowszechnianie lub modyfikowanie treści niniejszego dokumentu, częściowo lub w całości, bez formalnego zezwolenia, jest zabronione.

### **Wyłączenie odpowiedzialności**

Firma Hanuwa Vision przedsięwzięła wszelkie wysiłki, aby zapewnić spójność i poprawność treści niniejszej publikacji, ale nie zapewnia formalnych gwarancji. Użytkownik bierze pełną odpowiedzialność za stosowanie tego dokumentu i wyniki rezultaty. Firma Hanuwa Vision zastrzega sobie prawo do zmiany treści tego dokumentu bez uprzedzenia.

❖ Konstrukcja i dane techniczne urządzenia mogą ulec zmianie bez powiadomienia.

# informacje ogólne

---

## SPIS TREŚCI

---

**INFORMACJE OGÓLNE** 4 Co Znajduje Się W Opakowaniu

3

**INSTALACJA I PODŁĄCZANIE** 6 Montaż

6







**DODATEK** 12 Dane Techniczne  
12 Widok Urządzenia



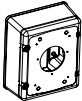





12

# informacje ogólne

## CO ZNAJDUJE SIĘ W OPAKOWANIU

Należy sprawdzić, czy w opakowaniu znajduje się kamera oraz wszystkie akcesoria.

Wygląd	Nazwa elementu	Liczba
	SKRZYŃKA MONTAŻOWA	1
	OBEJMA MONTAŻOWA	1
	Uszczelka (dla SBP-300WM1//WMW1)	1
	Uszczelka (dla SBP-300WM//WMW)	1
	GUMOWA OBUDOWA	1
	ADAPTER OBEJMY	1

Wygląd	Nazwa elementu	Liczba
	NASADKA MONTAŻOWA	5
	Łącznik NASADKI MONTAŻOWEJ	1
	Śruba M10 x L22 (do zamocowania obejmy montażowej)	4
	Śruba M8 x L20 (do zamocowania obudowy)	4
	Śruba M3 x L6 (do zamocowania adaptera obejmy i konwertera mediów)	4
	Wkręt M10 x L12 (do zamocowania SBP-300WM/WMW)	4
	Wkręt M10 x L20 (do zamocowania SBP-300WM/WMW1)	4
	Śruba M4 x L8 (do zamocowania konwertera mediów)	2

# instalacja i podłączenie

## MONTAŻ

1. Nacisnąć dźwignię blokującą na drzwiach w celu oddzielenia obudowy od drzwi.

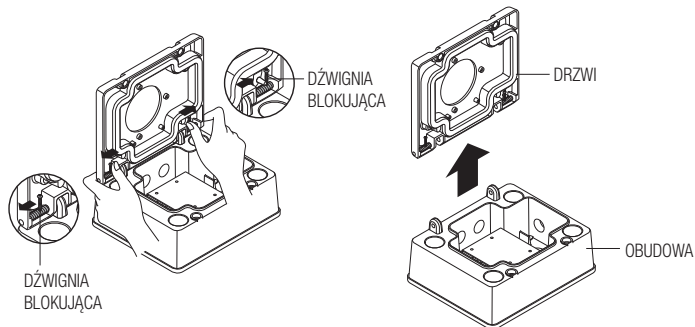

2. Odkręcić cztery śruby w celu oddzielenia adaptera obejmy. Zablokować nieużywany otwór w przewodzie rurowym za pomocą dołączonej nasadki montażowej. Użyć łącznika nasadki montażowej do zamocowania nasadki montażowej.

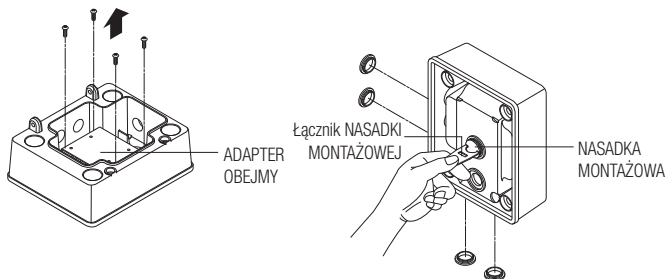

3. Usunąć taśmę dwustronną z tylnej części uszczelki i przymocować ją do drzwi. Przymocować uchwyt ścienny do drzwi za pomocą czterech śrub M10. <Ostrożnie dokręcić każdą z czterech śrub w taki sposób, aby uchwyt ścienny został równo dociśnięty do uszczelki.>

- Użycie uchwyty ściennego SBP-300WM1/SBP-300WMW1 (ze śrubami M10 x L20)

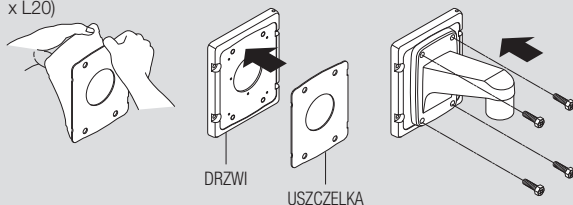

- Użycie uchwyty ściennego SBP-300WM/SBP-300MMW (umożliwiającego równe zamocowanie uchwyty ściennego w rowku uszczelki, jak pokazano w poniższym rysunku). (ze śrubami M10 x L12)

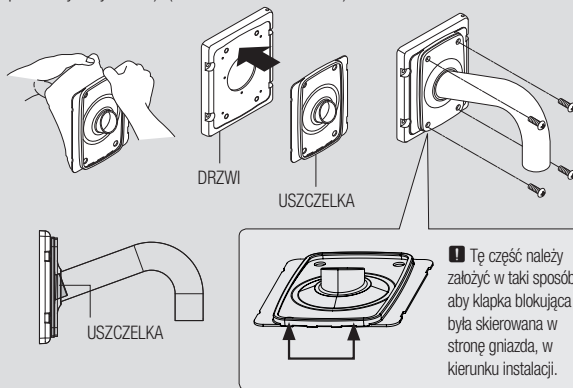



# instalacja i podłączenie

4. Przymocować obejmę montażową do ściany, uchwyty narożnego (SBP-300KM/SBP-300KMW) lub uchwyty słupkowe (SBP-300PM/SBP-300PMW) za pomocą śrub M10. Należy używać wyłącznie 4 śrub należących do wyposażenia, jak pokazano na poniższym rysunku.

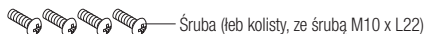

- Montaż na ścianie

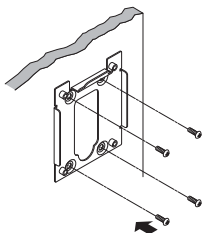

- Mocowanie narożne

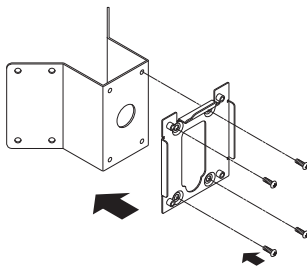

- Mocowanie słupkowe

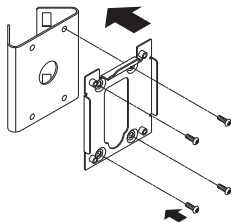

5. Umieścić obudowę na obejmie montażowej w sposób pokazany na rysunku.

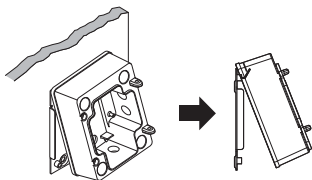

- W celu dokonania montażu na ścianie zamocować gumową obudowę w sposób pokazany na rysunku. Guma nie jest wodoodporna. Pełni wyłącznie funkcję dekoracyjną i służy do zakrycia luki. Dlatego też jeśli kabel został wprowadzony do głównej obudowy osobno i nie biegnie przez kanał umieszczony na ścianie, punkt wprowadzenia kabla musi być całkowicie wodoszczelny. W przeciwnym przypadku wycieki wody mogą spowodować problemy.

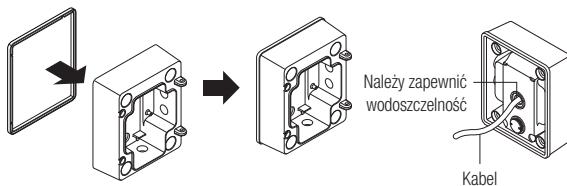

6. Przymocować obudowę do obejmie montażowej za pomocą 4 śrub M8 w sposób opisany w „Nr 4” w procedurze montażu.

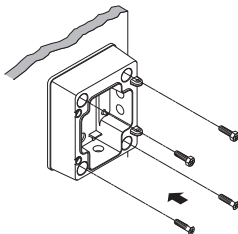

# instalacja i podłączenie

7. Wprowadzić zewnętrzny kabel do głównej obudowy, używając rury.  
Owinąć gwint śruby rury taśmą teflonową w celu zapobiegnięcia problemom związanym z wyciekiem wody.  
(Należy upewnić się, że wycieki wody nie spowodują problemów w punkcie wprowadzenia kabla).

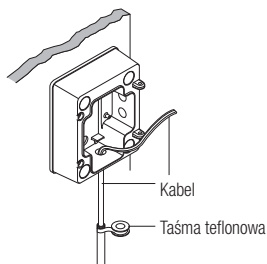

8. Zamontować zasilacz i konwerter mediów przy użyciu adaptera obejmowy, a następnie podłączyć zewnętrzny kabel.

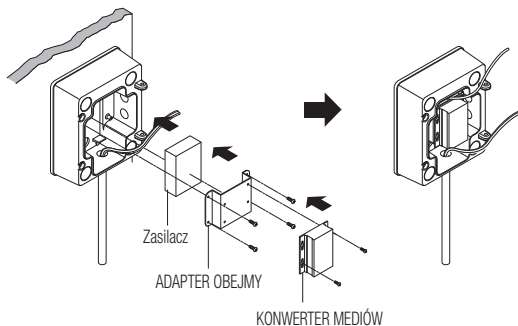

9. Wyciągnąć kabel przez drzwi i uchwyt ścienny, a następnie zamontować drzwi na obudowie. (Ustawić dźwignię blokującą ponownie w położeniu wyjściowym i upewnić się, że zawias jest prawidłowo przymocowany do obudowy).

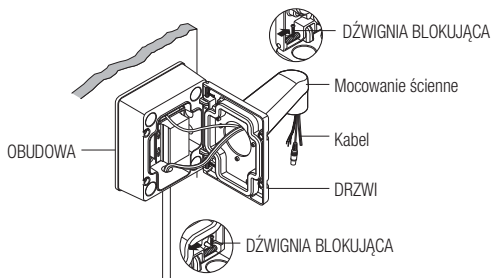

10. Przymocować drzwi do obudowy, używając klucza sześciokątnego. (Dokręcać śruby, dociskając drzwi ręką, jak pokazano na poniższym rysunku). Następnie ostrożnie dokręcić każdą ze śrub w taki sposób, aby drzwi zostały dokładnie dociśnięte do obudowy).

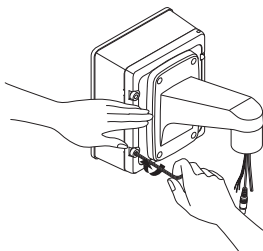

## DANE TECHNICZNE

Elementy	Opis
Wymiary (mm)	Szer. 185,0 x gl. 221,0 x wys. 94,3 (mm)
Waga	3.4kg
Materiał	STAL, ALUMINIUM, SILIKON

## WIDOK URZĄDZENIA

Jednostka: mm (inch)

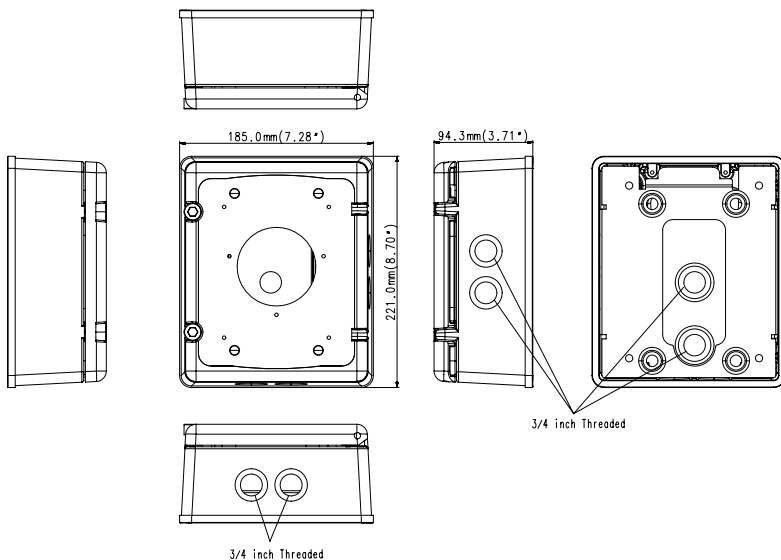



# **INSTALLATIEDOOS**

## Gebruikershandleiding

SBP-300NB (IVORY)  
SBP-300NBW (WHITE)



# Installatie Gebruikershandleiding

---

## Copyright

©2019 Hanuwa Vision Co., Ltd. Alle rechten voorbehouden.

## Handelsmerk

Elk van de hierin opgenomen handelsmerken is geregistreerd. De naam van dit product en andere genoemde handelsmerken in deze handleiding zijn een geregistreerd handelsmerk van hun respectief bedrijf.

## Beperking

Het auteursrecht van dit document is onder voorbehoud. In geen geval mag dit document, gedeeltelijk of geheel, zonder officiële toestemming worden gereproduceerd, verspreid of veranderd.

## Disclaimer

Hanuwa Vision doet zijn uiterste best om de integriteit en juistheid van de inhoud van dit document te verifiëren, maar biedt geen formele garantie hiervoor. Het gebruik van dit document en de daaruit voortvloeiende resultaten zijn volledig de verantwoordelijkheid van de gebruiker. Hanuwa Vision behoudt zich het recht voor de inhoud van dit document zonder voorafgaande kennisgeving te wijzigen.

❖ Vormgeving en specificaties kunnen zonder kennisgeving worden gewijzigd.



## INHOUD

---

**OVERZICHT** 4 Meegeleverde onderdelen

3

**INSTALLATIE EN AANSLUITING** 6 Installatie







6

**BIJLAGE** 12 Specificatie  
12 Productweergave

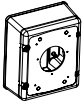
12

## MEEGELEVERDE ONDERDELEN

Controleer of de productverpakking zowel uw camera als alle accessoires bevat.

Uiterlijk	Itemnaam	Aantal
	INSTALLATIEDOOS	1
	INSTALLATIEBEUGEL	1
	Pakking (voor SBP-300WM1/WMW1)	1
	Pakking (voor SBP-300WM/WMW)	1
	RUBBEREN BEHUIZING	1
	BEUGELADAPTER	1

Uiterlijk	Itemnaam	Aantal
	MONTAGEKAP	5
	Bevestiging MONTAGEKAP	1
	M10 x L22 schroef (voor bevestigen van de installatiebeugel)	4
	M8 x L20 schroef (voor bevestigen van de behuizing)	4
	M3 x L6 schroef (voor bevestigen van de beugeladapter en mediaconverter)	4
	M10 x L12 sleutelbout (voor bevestigen van SBP-300WM/WMW)	4
	M10 x L20 sleutelbout (voor bevestigen van SBP-300WM1/WMW1)	4
	M4 x L8 schroef (voor bevestigen van de mediaconverter)	2

# installatie en aansluiting

## INSTALLATIE

1. Duw op de vergrendelingshendel op de deur om de behuizing en de deur te scheiden.

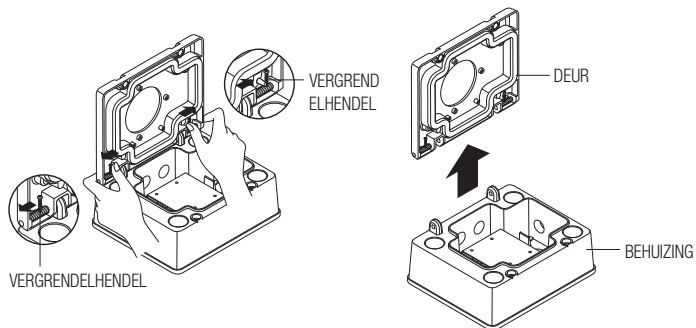

2. Maak de vier schroeven los om de beugeladapter te scheiden.  
Vergrendel de ongebruikte buisopening met de bevestigde montagekap.  
Gebruik een montagekapbevestiging voor het bevestigen van de montagekap.

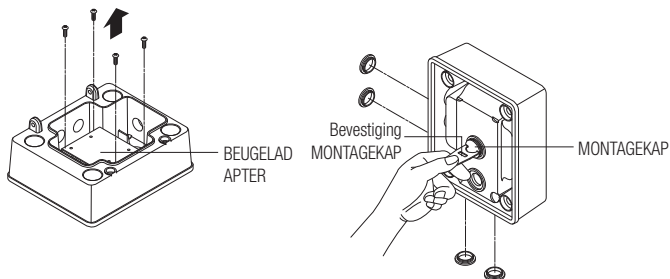

3. Verwijder de dubbelzijdige tapkraan op de achterkant van de pakking en bevestig deze aan de deur. Bevestig de wandmontage aan de deur met gebruik van de vier M10-schroeven.  
< Draai elk van de vier schroeven per keer een beetje vast zodat de wandmontage gelijkmatig tegen de pakking wordt gedrukt. >

- Gebruik van SBP-300WM1/SBP-300WMW1-wandmontage (met M10 x L20 schroeven)

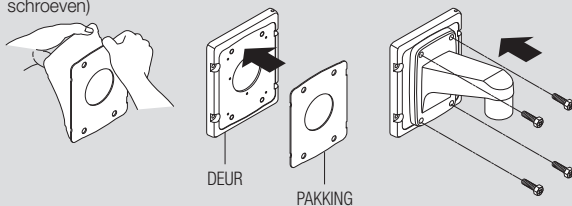

- Gebruik van SBP-300WM/SBP-300WMW-wandmontage (met gelijkmatige bevestiging van de wandmontage binnen de groef van de pakking, als getoond in de onderstaande afbeelding.) (met M10 x L12 schroeven)

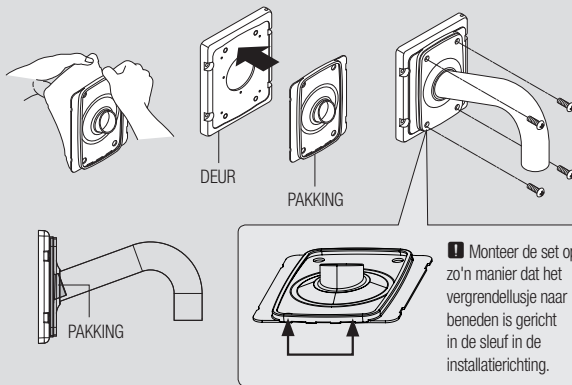

# installatie en aansluiting

4. Bevestig de installatiebeugel aan de wand, hoekmontage (SBP-300KM/SBP-300KMW) of stangmontage (SBP-300PM/SBP-300PMW) met gebruik van de M10-schroeven. Gebruik alleen de 4 schroeven die worden meegeleverd met de accessoires, als getoond in de onderstaande afbeelding.

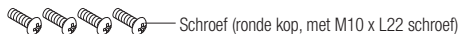

- Installatie aan de wand

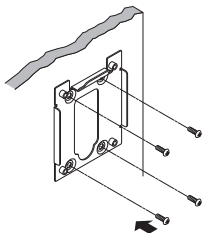

- Hoekmontage

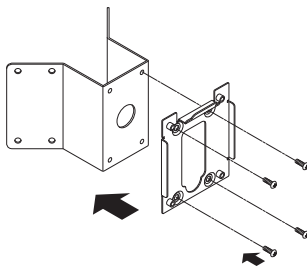

- Stangmontage

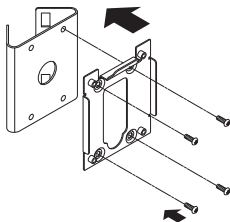

5. Plaats de behuizing op de installatiebeugel als getoond in de afbeelding.

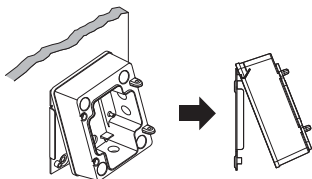

- Om het aan de wand te installeren, bevestigt u de rubberen behuizing als getoond in de afbeelding. Het rubber is niet waterbestendig. Het is enkel decoratief, bedoeld voor het verbergen van een opening. Als de kabel afzonderlijk in het hoofdhuis wordt gestoken en niet door de leiding op de wand, moet het ingangspunt van de kabel volledig waterbestendig zijn. Als men dit niet doet, kunnen waterlekken problemen veroorzaken.

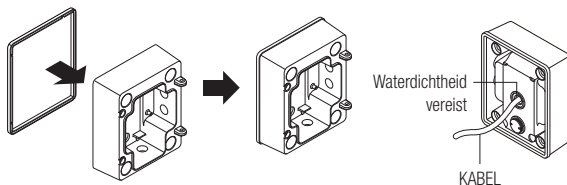

6. Bevestig de behuizing aan de installatiebeugel met gebruik van 4 M8-schroeven op dezelfde manier als "Nr. 4" in de installatieprocedure.

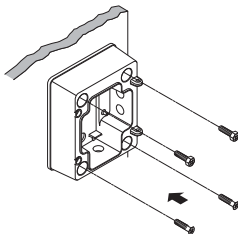

# installatie en aansluiting

7. Steek de externe kabel in het hoofdhuis met gebruik van een buis.  
Wikkel de schroefdraad van de buisschroef in met Teflon-tape voor bescherming tegen problemen als gevolg van waterlekken.  
(Zorg ervoor dat waterlekken geen problemen veroorzaken bij het toegangspunt van de kabel.)

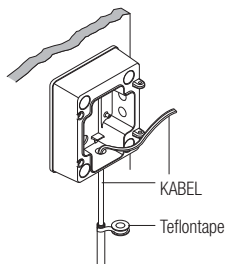

8. Installeer de stroomadapter en mediaconverter met gebruik van de beugeladapter en sluit de externe kabel aan.

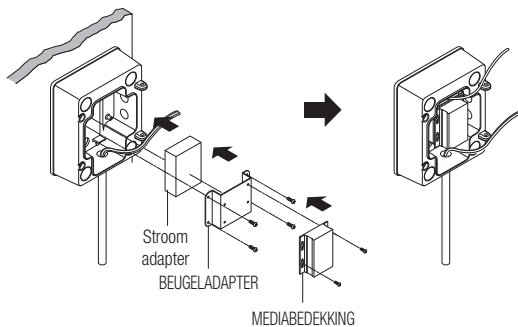



9. Trek de kabel door de deur en wandmontage en installeer de deur op de behuizing.  
(Zet de vergrendelingshendel terug naar de oorspronkelijke stand en controleer dat de scharnier op de juiste manier is bevestigd aan de behuizing.)

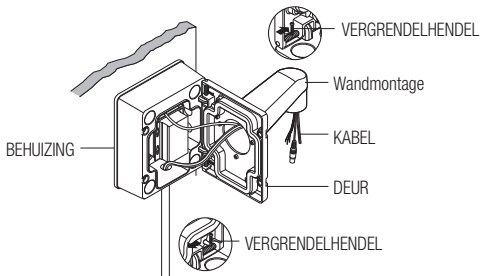

10. Maak de deur vast aan de behuizing met gebruik van een zeskantsleutel. (Draai de schroeven vast terwijl u met uw hand op de deur drukt, als getoond in de onderstaande afbeelding. Draai vervolgens elk van de schroeven per keer een beetje vast om ervoor te zorgen dat de deur stevig tegen de behuizing wordt gedrukt.)

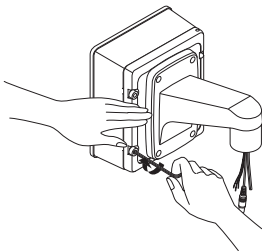

## SPECIFICATIE

Items	Omschrijving
Afmetingen (mm)	B185,0 x D221,0 x H94,3 (mm)
Gewicht	3.4kg
Materiaal	STAAL, ALUMINIUM, SILICONE

## PRODUCTWEERGAVE

eenheid: mm (inches)

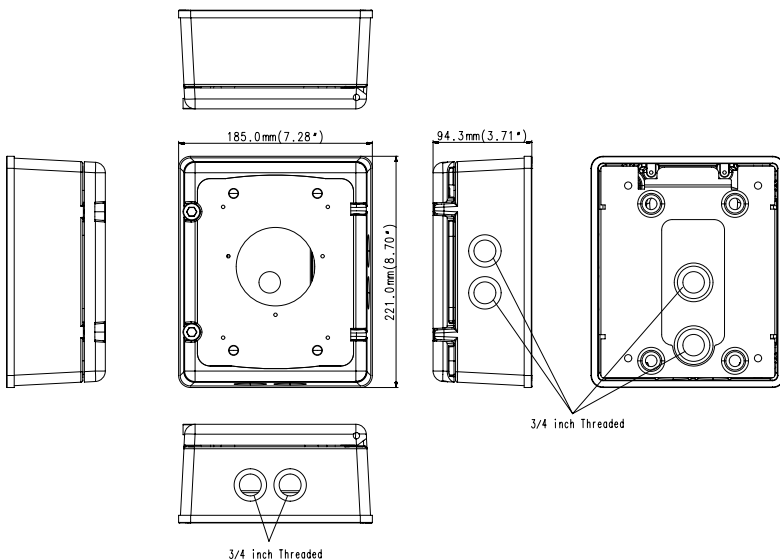



# CAIXA DE INSTALAÇÃO

## Manual do usuário

SBP-300NB (IVORY)  
SBP-300NBW (WHITE)



# Caixa de Instalação

## Manual do usuário

---

### Direitos autorais

©2019 Hanuwa Vision Co., Ltd. Todos os direitos reservados.

### Marca comercial

Cada uma das marcas aqui incluídas se encontram registradas. O nome deste produto e as outras marcas registradas mencionadas neste manual são marcas registradas de sua respectiva companhia.

### Restrição

Os direitos autorais em este documentos são reservados. Em nenhuma circunstância poderá o mesmo ser reproduzido, distribuído ou alterado, no todo ou em parte, sem autorização formal.

### Renúncia

A Hanuwa Vision esforça-se ao máximo para verificar a integridade e exatidão do conteúdo deste documento, mas nenhuma garantia formal deve ser fornecida. O uso deste documento e dos resultados subseqüentes deve ser inteiramente responsabilidade do usuário. A Hanuwa Vision reserva-se o direito de alterar o conteúdo deste documento sem aviso prévio.

❖ Design e especificações estão sujeitos a alterações sem aviso prévio.

## INDHOLD

---

**VISÃO GERAL** 4 Itens Fornecidos

3

**INSTALAÇÃO E CONEXÃO** 6 Instalação

6







**APÊNDICE** 12 Specification  
12 Exibição do Produto



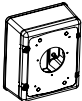





12

# visão geral

## ITENS FORNECIDOS

Verifique se sua câmera e os acessórios estão inclusos no pacote do produto.

Aparência	Nome do item	Quantidade
	CAIXA DE INSTALAÇÃO	1
	INSTALE O SUPORTE	1
	Junta (para SBP-300WM/WMW1)	1
	Junta (para SBP-300WM/WMW)	1
	INVÓLUCRO DE BORRACHA	1
	ADAPTADOR DO SUPORTE	1

Aparência	Nome do item	Quantidade
	TAMPA DE MONTAGEM	5
	Prendedor da TAMPA DE MONTAGEM	1
	Parafuso M10 x L22 (para acoplar o suporte de instalação)	4
	Parafuso M8 x L20 (para acoplar o invólucro)	4
	Parafuso M3 x L6 (para acoplar o adaptador de suporte e conversor de mídia)	4
	Parafuso M10 chave x L12 (para acoplar SBP-300WM/WMW)	4
	Parafuso M10 chave x L20 (para acoplar SBP-300WM1/WMW1)	4
	Parafuso M4 x L8 (para acoplar o conversor de mídia)	2



# instalação e conexão

## INSTALAÇÃO

1. Empurre a alavanca de bloqueio na porta para separar o invólucro e a porta.

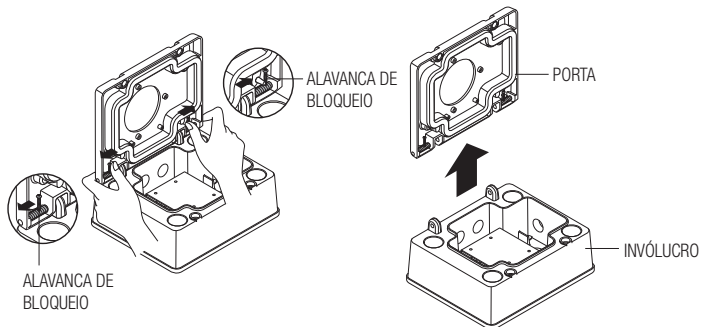

2. Desaparafuse os quatro parafusos para separar o adaptador do suporte. Bloqueie o orifício dos tubos não utilizado com a tampa de montagem em anexo. Use um prendedor para fixar a tampa de montagem.

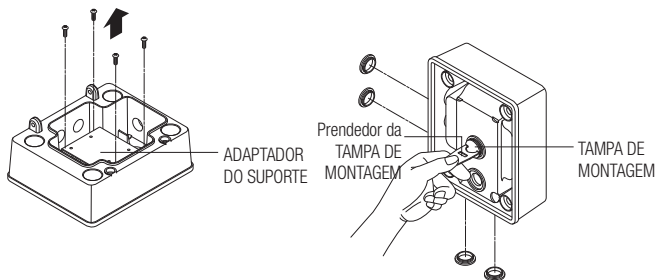

3. Remova a torneira de dupla face no lado de trás da junta e fixe-a à porta.

Fixe o suporte de parede à porta com os quatro parafusos M10.

< Aperte cada um dos quatro parafusos um pouco de cada vez, de modo que o suporte de parede seja uniformemente pressionado contra a junta. >

- Uso do suporte de parede SBP-300WM1/SBP-300WMW1 (com parafusos M10 x L20)

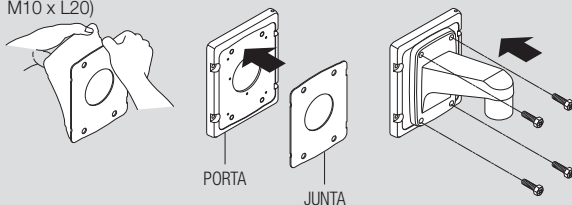

- Uso de suporte de parede SBP-300WM/SBP-300WMW (fixando uniformemente o suporte de montagem no interior do sulco da junta, como mostrado na imagem abaixo.) (com parafusos M10 x L12)

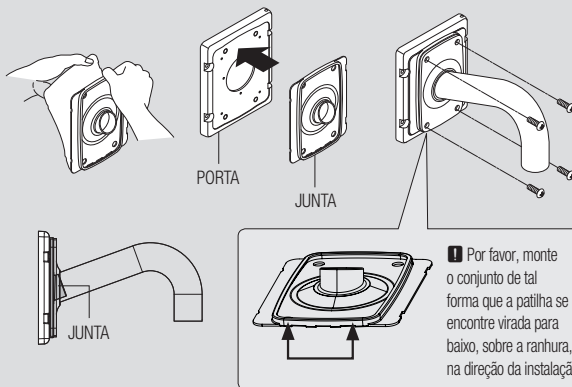

# instalação e conexão

4. Fixe o braço de instalação à parede, ao suporte de canto (SBP-300KM/SBP-300KMW) ou à montagem do poste (SBP-300PM/SBP-300PMW) usando os parafusos M10. Utilize apenas os 4 parafusos incluídos nos acessórios, como mostrado na imagem abaixo.



- Instalação na parede

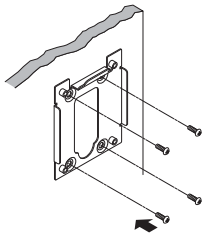

- Montagem no canto

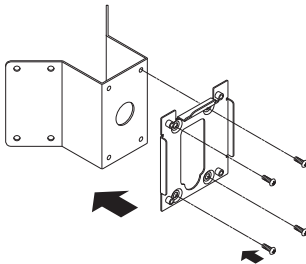

- Montagem em poste

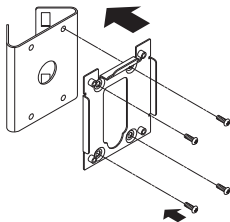

5. Coloque o invólucro no braço de instalação, como é mostrado na imagem.

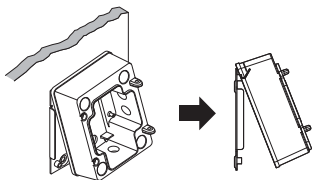

- Para instalá-lo na parede, coloque o invólucro de borracha, como se mostra na figura. A borracha não é impermeável. É apenas decorativa, servindo para ocultar uma folga. Portanto, se o cabo for inserido no corpo principal em separado e não através da conduta na parede, o ponto de inserção do cabo deve ser completamente à prova de água. Se isso não for feito, quaisquer vazamentos de água poderão causar problemas.

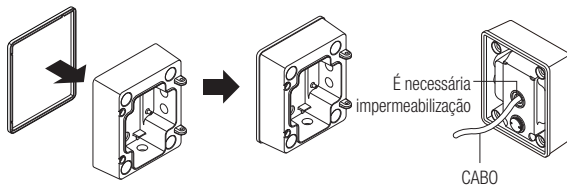

6. Fixe o invólucro ao braço de instalação utilizando 4 parafusos M8 da mesma forma que no procedimento de instalação "Nº.4".

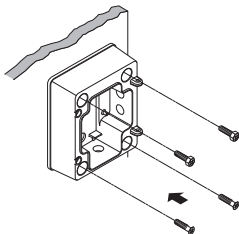

# instalação e conexão

- Insira o cabo externo no corpo principal usando um tubo.  
Enrole a rosca do parafuso de tubo com fita adesiva Teflon para proteger contra problemas de vazamento de água.  
(Certifique-se de que vazamentos de água não irão causar problema no ponto de inserção do cabo.)

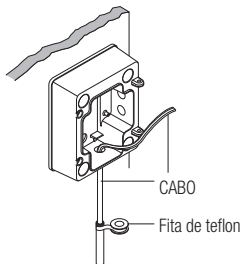

- Instale o adaptador de energia e conversor de mídia usando o braço adaptador, e conecte o cabo externo.

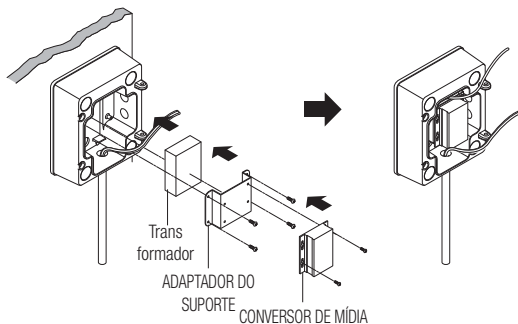

9. Puxe o cabo para fora através da porta e suporte de parede e monte a porta no invólucro. (Recoloque a alavanca de bloqueio em sua posição original e verifique se a dobradiça está devidamente ligada ao invólucro.)

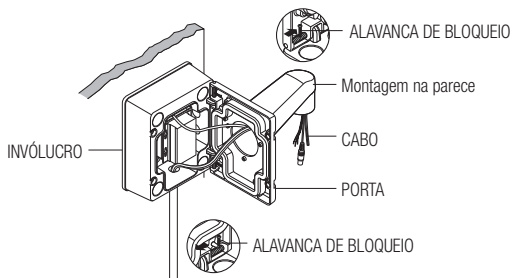

10. Fixe a porta ao invólucro usando uma chave hexagonal. (Aperte os parafusos enquanto pressiona a porta com a mão, como se mostra na imagem abaixo. Em seguida, aperte cada um dos parafusos, um pouco de cada vez para se certificar de que a porta está fortemente pressionada contra o invólucro.)

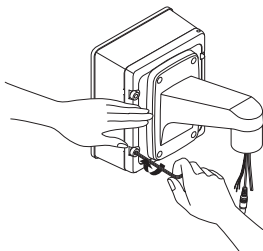

## ESPECIFICACOES

Itens	Descrição
Dimensões (mm)	L185,0 x P221,0 x A94,3 (mm)
Peso	3.4kg
Material	AÇO, ALUMÍNIO, SILÍCIO

## EXIBIÇÃO DO PRODUTO

Unidade: mm (polegadas)

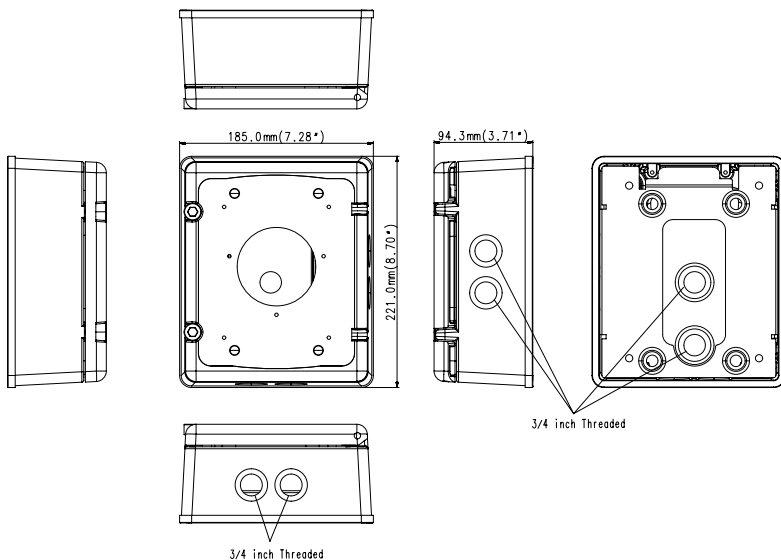





# 安装盒 用户手册

SBP-300NB (IVORY)  
SBP-300NBW (WHITE)



# 安装盒 用户手册

---

## 版权

©2019 Hanuha Vision Co., Ltd. 版权所有。

## 商标

本文件中的每个商标均经过注册。本产品的名称以及本手册中提到的其他商标均为各自公司的注册商标。

## 限制

本手册受著作权保护。未经正式授权，在任何情况下均不得复制、传阅或更改本文件或其任何部分。

## 免责声明

Hanuha Vision 尽力验证本文中内容的完整性和正确性，但不能提供正式保证。

使用本文档及所产生的结果完全由用户自行负责。

Hanuha Vision 保留更改本文档的内容而不提前通知的权利。

❖ 设计和规格可能会随时更改，恕不提前通知。

# 概述

---

## 目录

---

概述 4 随机提供的物品

3

安装与连接 6 安装

6

附录 12 规格  
12 产品视图

12

# 概述

## 随机提供的物品

请检查产品包装内是否已包括摄像机和所有附件。

外观	项目名称	数量
	安装盒	1
	安装支架	1
	垫片(用于 SBP-300WM/WMW1)	1
	垫片(用于 SBP-300WM/WMW)	1
	橡胶套	1
	支架适配器	1

外观	项目名称	数量
	安装盖	5
	安装帽紧固件	1
	M10 x L22 螺钉(用于固定安装支架)	4
	M8 x L20 螺钉(用于固定外罩)	4
	M3 x L6 螺钉 (用于固定支架适配器和媒体转换工具)	4
	M10 x L12 扳手螺栓(用于固定 SBP-300WM/WMW)	4
	M10 x L20 扳手螺栓(用于固定 SBP-300WM1/WMW1)	4
	M4 x L8 螺钉(用于固定媒体转换工具)	2

# 安装与连接

## 安装

1. 推动门上的锁定杆以将外罩和门分离。

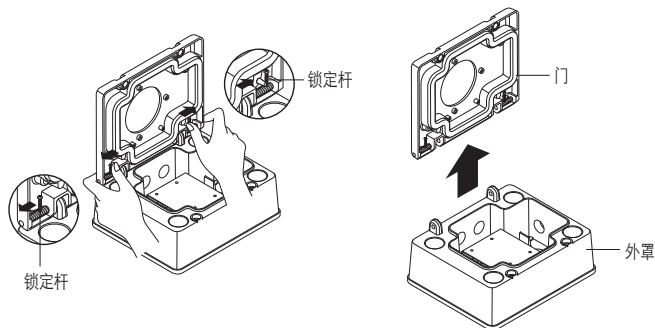

2. 松开四个螺钉以拆下支架适配器。  
用附带的安装盖锁住未使用的管道孔。  
使用安装盖紧固件固定安装盖。

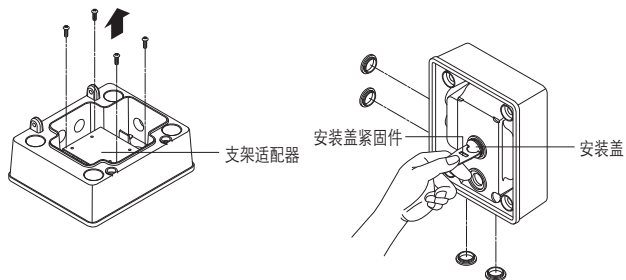

3. 取下垫片背面的双面胶, 将其贴到门上。

使用四个 M10 螺钉将壁挂支架固定到门上。

< 拧紧四个螺钉, 一次拧紧一点儿, 以便壁挂支架均匀地压到垫片上。>

- 使用 SBP-300WM1/SBP-300MMW1 壁挂支架 (使用 M10 x L20 螺钉)

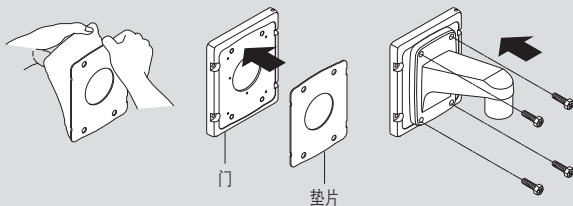

- 使用 SBP-300WM/SBP-300MMW 壁挂支架 (将壁挂支架均匀固定在垫片沟槽内, 如下图所示。)(使用 M10 x L12 螺钉)

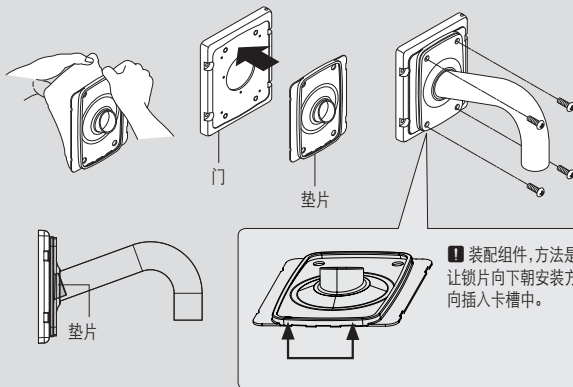

# 安装与连接

4. 使用 M10 螺钉将安装支架固定到墙壁、墙角安装支架 (SBP-300KM/SBP-300KMW) 或插竿式安装支架 (SBP-300PM/SBP-300PMW) 上。  
只使用附件中提供的 4 个螺钉, 如下图所示。



- 在墙壁上安装

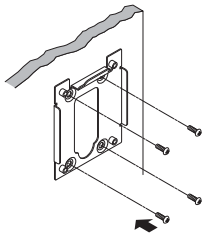

- 墙角安装

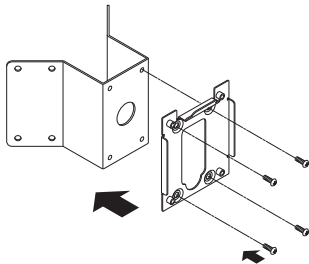

- 插竿式安装

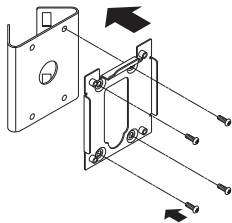



5. 将外罩放置到安装支架上,如图所示。

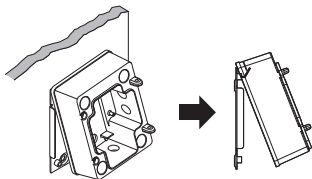

- 若要将其安装到墙壁上,请如图所示安装橡胶外罩。  
橡胶不防水。只起装饰作用,为的是填补间隙。  
因此,如果将电缆单独插入机身,而并不通过墙壁上的导管,那么电缆的插入点必须完全防水。  
如果不这样做,那么漏任何一点儿水都可能会导致出现问题。

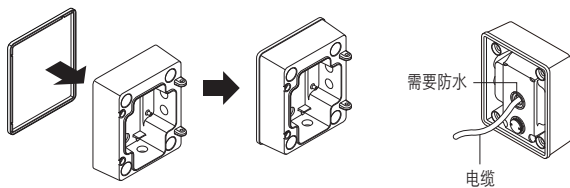

6. 使用 4 个 M8 螺钉将外罩固定到安装支架上,固定方式与安装过程中的“第 4 步”相同。

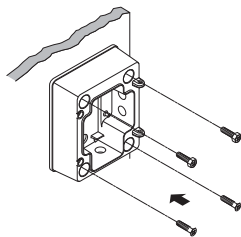

# 安装与连接

7. 通过使用管道将外部电缆插入机身。  
用特富龙胶带包裹管螺纹，以防止出现漏水问题。  
(确保在电缆插入点不会出现漏水问题。)

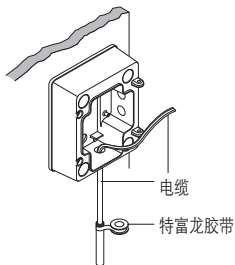

8. 使用支架适配器安装电源适配器和媒体转换工具，并连接外部电缆。

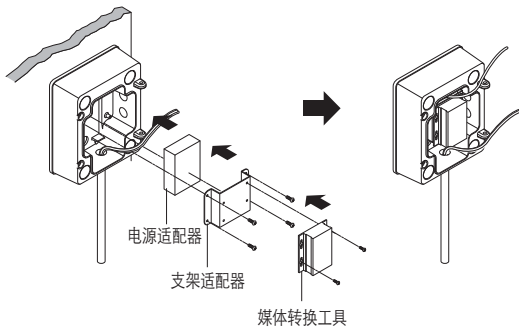

9. 从门和壁挂支架中拉出电缆并将门安装到外罩上。  
(将锁定杆推回其原始位置并检查铰链是否正确安装到外罩上。)

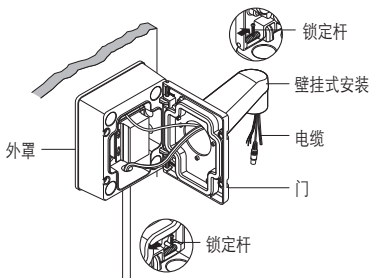

10. 使用六角扳手将门紧固到外罩上。(在按住门的同时用手拧紧螺钉,如下图所示。然后拧紧各个螺钉,一次拧紧一点儿,以确保门紧紧压在外罩上。)

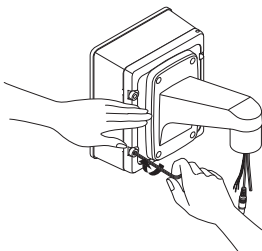

# 附录

## 规格

项目	说明
外形尺寸 (mm)	宽 185.0 x 深 221.0 x 高 94.3 (mm)
重量	3.4公斤
材料	钢、铝、硅

## 产品视图

单位：毫米(英寸)

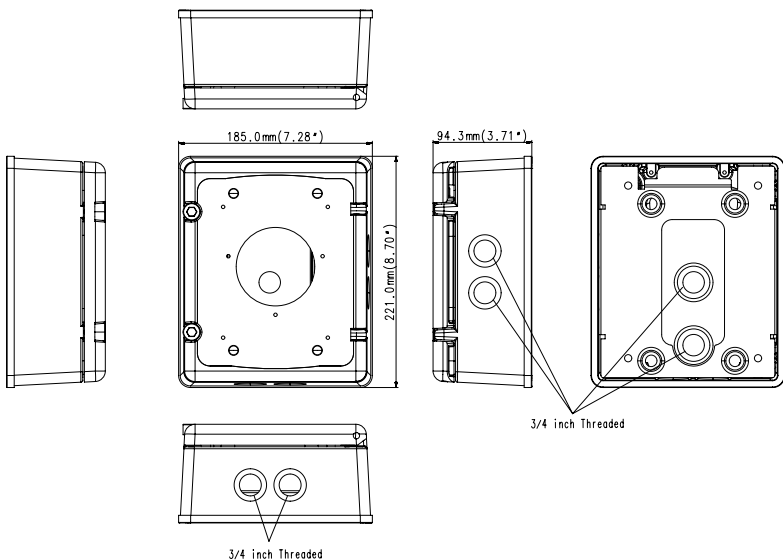



# インストールボックス ユーザーマニュアル

SBP-300NB (IVORY)  
SBP-300NBW (WHITE)



# ネットワークカメラ ユーザーマニュアル

---

## Copyright

©2019 Hanuwa Vision Co., Ltd. All rights reserved.

## 商標について

本書に記載されている各商標は登録済みです。本書に記載されている本製品の名称およびその他の商標は、各社の登録商標です。

## 制約について

本書の著作権は留保されています。どのような状況であっても、本書の一部または全体を複製、配布または変更するには、正式な認可が必要です。

## 免責事項について

Hanuwa Vision はマニュアルの完全性および正確性について万全を期しておりますが、その内容について公式に保証するものではありません。このマニュアルの使用およびその結果については、すべてユーザーが責任を負うことになります。

Hanuwa Vision は事前の通知なしにこのマニュアルの内容を変更する権利を留保します。

◆ 設計および仕様は予告なく変更する場合があります。

# 概要

---

## 目次

---

概要 4 キット内容

3

取付けおよび接続 6 取り付け

6

付録 12 仕様  
12 製品ビュー

12



# 概要

## キット内容

製品パッケージに、カメラと付属品がすべて同梱されていることをご確認ください。

外観	品目名	数量
	インストールボックス	1
	取り付けブラケット	1
	ガスケット (SBP-300WM1/WMW1用)	1
	ガスケット (SBP-300WM/WMW用)	1
	ラバーハウジング	1
	ブラケットアダプター	1

外観	品目名	数量
	マウントキャップ	5
	マウントキャップファスナー	1
	M10 x L22ねじ(取付部ブラケット取り付け用)	4
	M8 x L20ねじ(ハウジング取り付け用)	4
	M3 x L6ねじ (ブラケットアダプターおよびメディアコンパート取り付け用)	4
	M10 x L12レンチボルト (SBP-300WM/WMW取り付け用)	4
	M10 x L20レンチボルト (SBP-300WM1/WMW1取り付け用)	4
	M4 x L8ねじ(メディアコンパート取り付け用)	2

# 取付けおよび接続

## 取り付け

1. ドアのロックingleレバーを押し、ハウジングとドアを分離します。

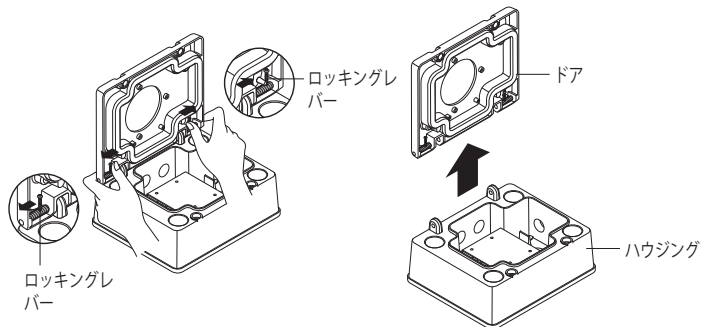

2. ねじ4本を元に戻し、ブラケットアダプターを分離します。  
未使用の配管穴を、付属のマウントキャップで閉じます。  
マウントキャップファスナーを使い、マウントキャップを取り付けます。

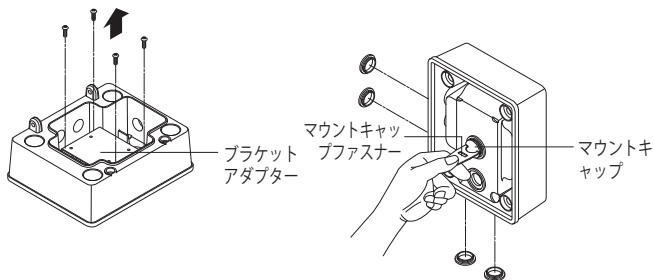

3. ガasket後側の両面タップを取り外し、ドアに付けます。  
 M10ねじ4本を使い、壁マウントをドアに取り付けます。  
 <ねじ4本を1本ずつ、少し締め、壁マウントをガasketにムラ無く締め付けます。>

- SBP-300WM1/SBP-300WMW1壁マウントの使用（M10 x L20ねじを使用）

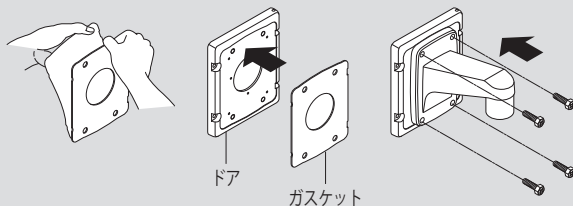

- SBP-300WM/SBP-300WMW壁マウントの使用（ガasket溝内部の壁マウントを、下の画像に示されているようにムラなく固定。）（M10 x L12ねじを使用）

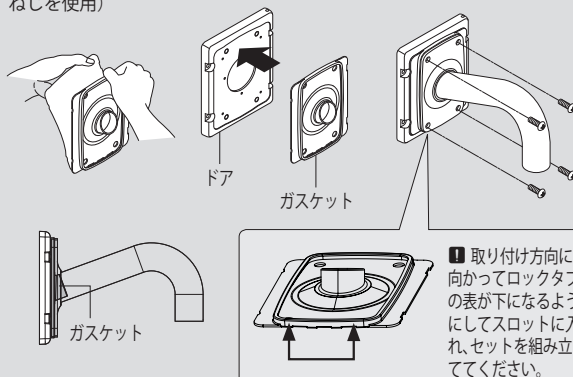

# 取付けおよび接続

4. M10ねじを使い、取り付け用ブラケットを壁、コーナーマウント (SBP-300KM/SBP-300KMW) またはボールマウント (SBP-300PM/SBP-300PMW) に取り付けます。下の画像に表示されている通り、付属のねじ4本のみを使用してください。

 ねじ (サーキュラーヘッド、M10 x L22ねじ使用)

- 壁への取り付け

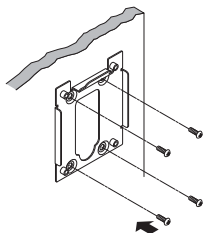

- コーナーマウント

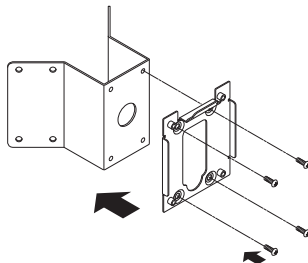

- ボールマウント

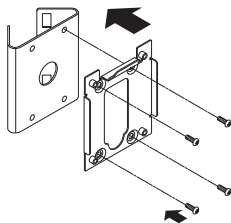

5. 画像に示されている通り、ハウジングを取り付け用ブラケットに配置します。

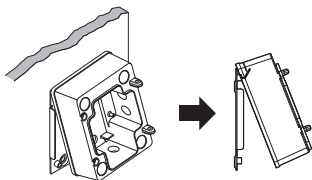

- 壁に取り付けるには、図に示されている通り、ラバーハウジングを取り付けます。ラバーは防水非対応です。これは装飾目的のみで、隙間を隠します。そのため、ケーブルを壁のダクトを通してではなく、本体に別々に挿入した場合、ケーブルを挿入する箇所は完全に防水対応でなければいけません。そうでない場合、水漏れがあった場合に問題が起こる可能性があります。

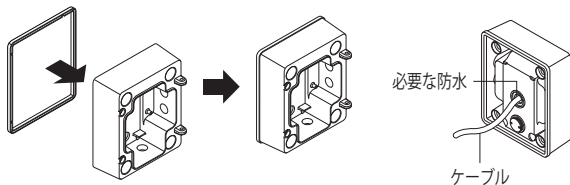

6. M8ねじを4本使用し、取り付けて「4番」と同じ方法でハウジングを取り付け用ブラケットに固定します。

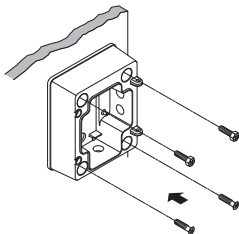

# 取付けおよび接続

7. パイプを使い、外部ケーブルを本体に挿入します。  
パイプのねじ山をテフロンテープで包み、水漏れの問題から守ります。  
(水漏れによりケーブル挿入箇所で問題が発生しないようにしてください。)

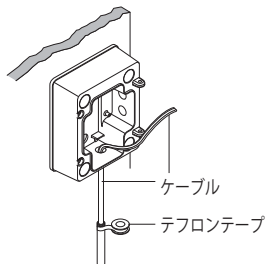

8. ブラケットアダプターを使い、電源アダプターとメディアコンパートを取り付け、外部ケーブルを接続します。

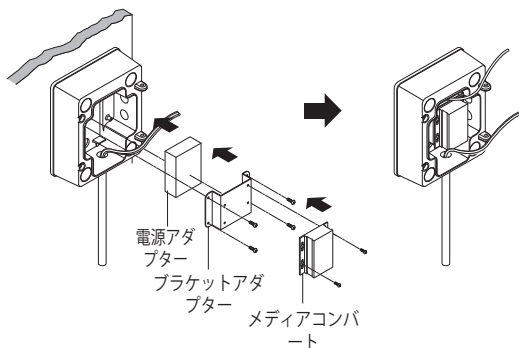

9. ケーブルをドアおよび壁マウントを通して引き出し、ハウジングに取り付けてください。  
(ロックングレバーを元の位置に戻し、ヒンジがハウジングに正しく取り付けられていることを確認してください。)

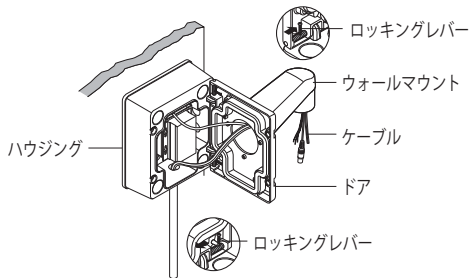

10. 六角レンチを使い、ドアをハウジングに固定してください。(下の画像に示されている通り、ドアを手で押さえた状態でねじを締めます。それからねじ4本を1本ずつ、少し締め、ドアがハウジングにしっかりと押しつけられるようにします。)

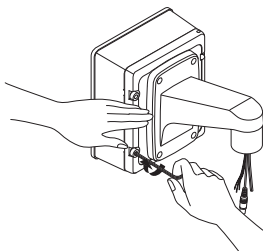



# 付録

## 仕様

項目	説明
寸法(mm)	幅185.0 x 奥行221.0 x 高さ94.3 (mm)
重量	3.4kg
材料	鋼、アルミニウム、シリコン

## 製品ビュー

単位: mm(インチ)

