

Aperio® Online Mechanical Installation Manual

Document No: ST-001323-B, Issue date: 11 October 2013



Table of Contents

1 Introduction	3
Purpose.....	3
Scope.....	3
Applicable Products.....	3
Product availability.....	3
Aperio support in the EAC system	3
References	3
2 System Overview	4
The Aperio system	4
The Aperio Programming Application	4
Regulatory and security information.....	4
Communication hub versions and EAC interface.....	4
3 Planning the Installation	5
Evaluating radio interference	6
4 Mechanical Installation	7
Mechanical installation AH15	7
Installation examples for AH15 communication hub with E-cylinder locks	9
Installation examples for AH15 communication hub with other type of locks	14
Mechanical installation AH20/30/40	17
Installation examples for AH20/30/40 communication hub	19
5 Configuration and Connection of Cables	25
AH15 (RS-485).....	25
AH15 (Wiegand).....	28
AH20 (Wiegand).....	32
AH30 (RS-485).....	37
AH40 (Ethernet).....	41
6 Appendix.....	42
Selecting the correct EAC address (AH15/AH30)	42
Installation examples.....	44
Upgrading existing installations	45
7 LED Indications	46
Communication Hub LED indications	46
AH40 Ethernet LED indication.....	46
Lock LED indications	47

1 Introduction

Purpose

The main purpose of this manual is to provide necessary information to plan and perform the mechanical installation of Aperio communication hubs. Intended reader is installation personnel, project managers and people with similar responsibilities.

Scope

This manual covers information and instructions for a complete mechanical installation of Aperio online products.

After completing the mechanical installation of the Aperio communication hubs, refer to ST-001322-Aperio Online Quick Installation Guide and ST-001321-Aperio Online Programming Application Manual software for setup of Aperio products for final use with an EAC.

Applicable Products

This manual can be used for all versions of communication hubs

Product availability

The products included in this manual may not be available on all markets. Please check your local ASSA ABLOY company for details.

Aperio support in the EAC system

Note that the Aperio support may vary depending on the Aperio communication hub used and the level of integration. Please contact your OEM for details.

Abbreviations and Definitions

Abbreviation	Definition
EAC	Electronic Access Control. The system controlling access decisions.
DIP	Dual in-line Package. A manual electric switch used for settings on the communication hub.
RFID	Radio Frequency Identification. The credential technology used.

References

[1]	ST-001322-Aperio Online Quick Installation Guide
[2]	ST-001321-Aperio Online Programming Application Manual

2 System Overview

Figure 1.
Aperio technology
overview

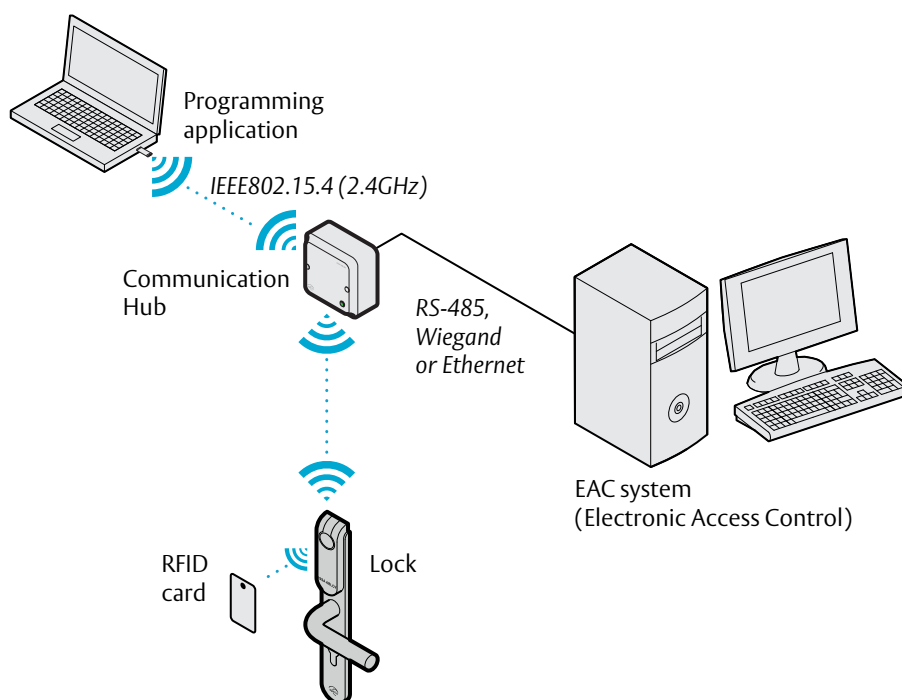

The Aperio system

The Aperio system is used in the following way: The user holds an RFID card in front of the lock. The lock sends card credentials wirelessly to the Communication Hub and the Communication Hub (wired through RS-485, Ethernet or Wiegand) then communicates with an EAC (Electronic Access Control) system. The EAC system then makes the access decision. The decision is sent via the Communication Hub to the lock and access is granted or denied.

The Aperio Programming Application

The Programming Application is used for the configuration of a door installation. It is installed on a laptop. The laptop has an Aperio USB radio device connected to one of its USB ports. The USB radio device enables the application to connect via a Communication Hub to the door lock. The lock communicates via the Communication Hub either with the EAC or with the Programming Application. Read more in the Aperio Online Programming Application Manual.

Regulatory and security information

Refer to the Programming Application manual for regulatory and security information.

Communication hub versions and EAC interface

There are four communication hub types according to the table below:

Version	Interface	Maximum number of locks/sensors
AH15	Wiegand/RS 485*	1
AH20	Wiegand	1
AH30	RS-485	8
AH40	IP (Ethernet)	8

*) The firmware type loaded into the communication hub controls what interface is enabled.

3 Planning the Installation

It is very important to find the best possible placement of the communication hub, in order to get a stable and reliable radio link. Depending on the floor plan of the installation site, type of communication hubs used, use of external antenna and presence of disturbances will all affect the positioning of communication hubs. Follow these guidelines to find the best installation placement, also see following sections for installation examples.

Placement options for communication hub

General installation guidelines:

- Try to install so that locks and communication hub "see" each other with the LED on the communication hub "pointing" towards the lock.
- If this is not possible, find a placement so that there are no concrete and metal objects in between the lock and the communication hub.
- Avoid installing the communication hub in a low position, where radio waves can be blocked by objects or people passing by during operation.
- When the internal antenna is used, the radio coverage backwards is limited to 0,5 m/3 ft for AH15 and 3 m/10 ft for AH20/30/40. The coverage also depends on the type of wall it is installed on.
- When the external antenna is used, the radio coverage will be focused perpendicular to the direction of the antenna and in some directions the range may decrease. However the maximum range will not increase. See section "Radio coverage for external antenna" on page 18 for details.
- The lock and the communication hub should be placed on the same side of the door. Shorter distance and "light" materials in the walls also permits placement on opposite sides.
- Be aware of that nearby metallic sheet or mesh will attenuate the radio signal. Inner ceiling, for example, is sometimes covered with foil or metallic mesh.
- Mirrors, heat insulating windows and larger metallic objects (like cable ladders) have a significant effect on radio signals and should not be closer than 20 cm (8 inches) from lock or Communication Hub.
- In difficult environments (for example where heavy radio interference is expected), or when the requirements on the radio link quality are very high, it is recommended to keep the distance between the lock and the communication hub well below the maximum recommended distance. There is no minimum distance.

Evaluating radio interference

Always evaluate the installation site for possible sources of disturbance. Follow these installation guidelines regarding disturbances to ensure adequate functionality:

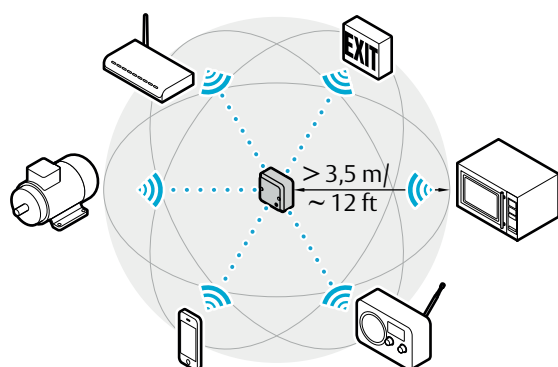

Figure 2. Minimum distance to radio emitting devices

- WiFi/WLAN routers and other radio transmitters operating in the 2.4 GHz band should be kept at least 3,5 meters from the Communication Hub and lock.
- Other possible sources of interference include microwave ovens, electric motors, wireless emergency exit signs and other high power electrical equipment. Keep at least 3,5 meters distance to Communication Hub or lock.

i In difficult environments with radio interference or presence of metal objects attenuating the signal it is recommended to test the radio signal before mounting the communication hub permanently.

4 Mechanical Installation

This chapter includes guidelines for selecting the correct installation place for communication hubs in an Aperio online EAC system. This chapter also describes how to connect the communication hubs to the power supply.

Mechanical installation AH15

Minimum distance between AH15 communication hubs

If necessary, several communication hubs can be positioned together with a minimum of 0,2 meter in between the hubs (or use one AH30 communication hub to pair with all three locks).

Figure 3. Minimum distance between AH15 communication hubs with E100 locks

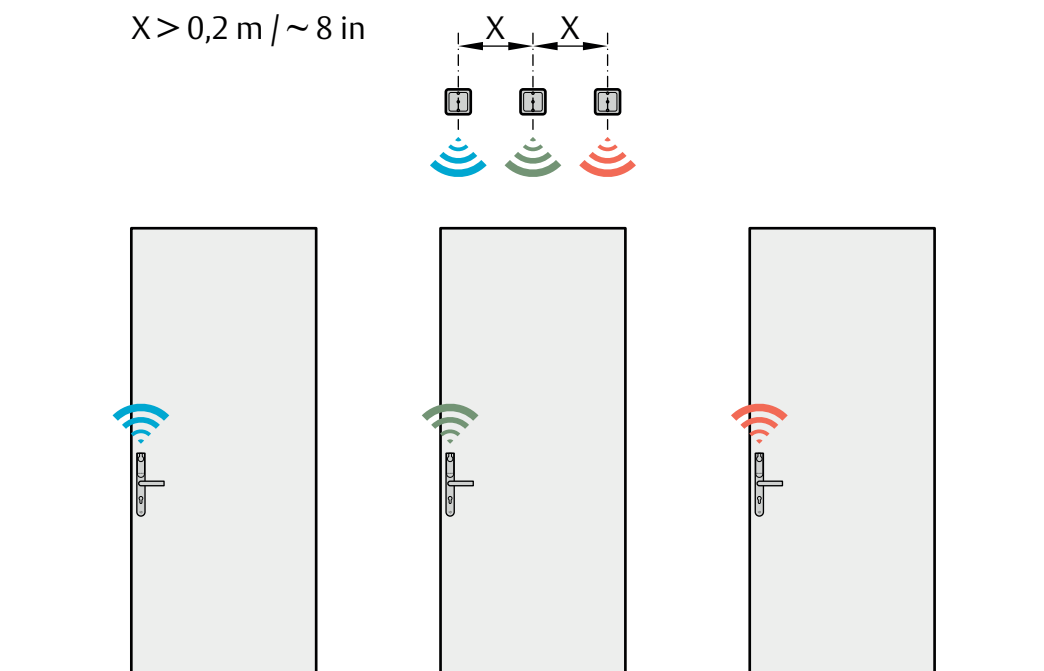

Installation examples for AH15 communication hub with E-cylinder locks

Short/long Corridors

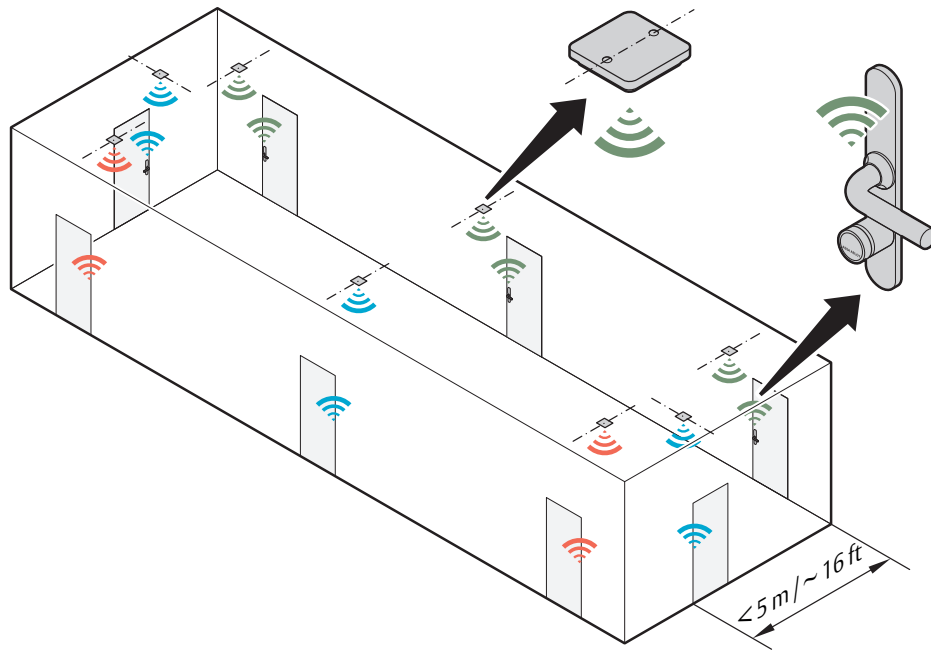

Alternate installation:

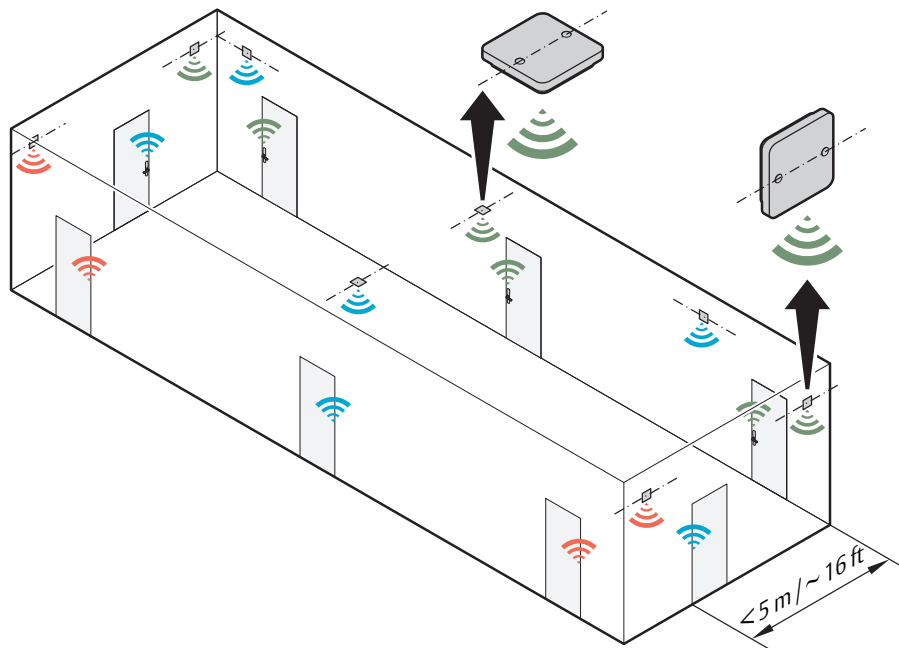

High ceiling

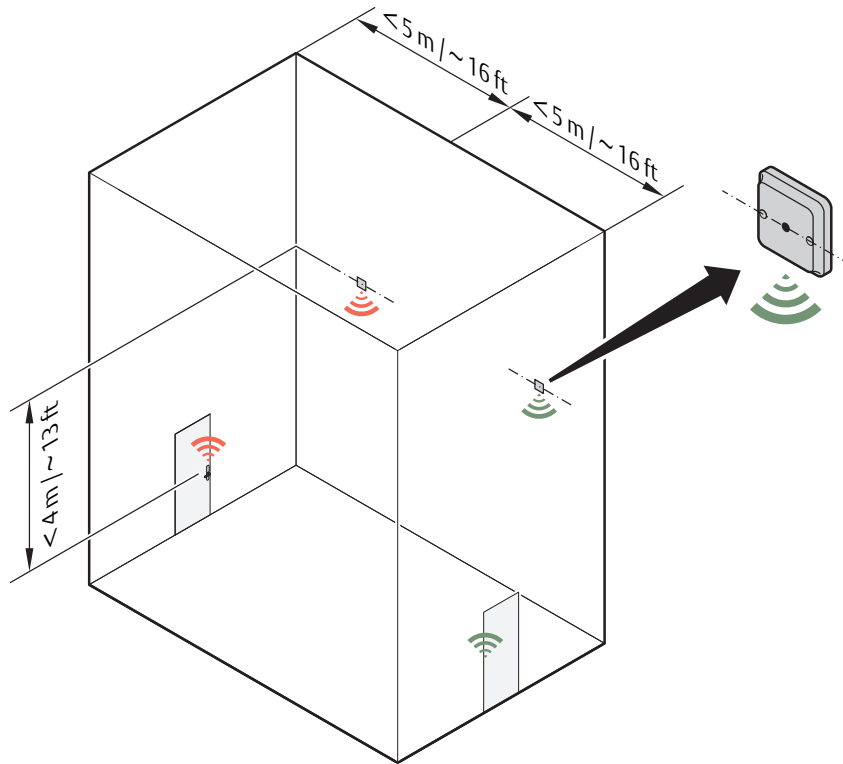

Low ceiling

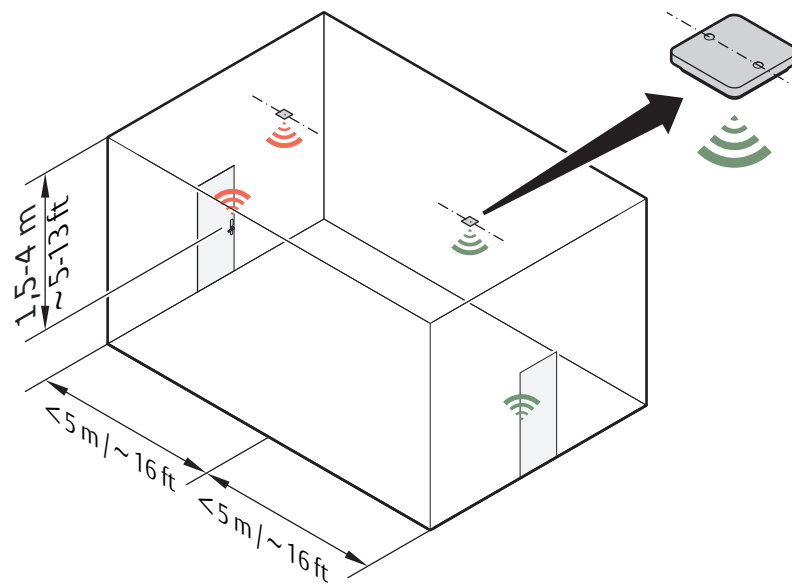

Square rooms

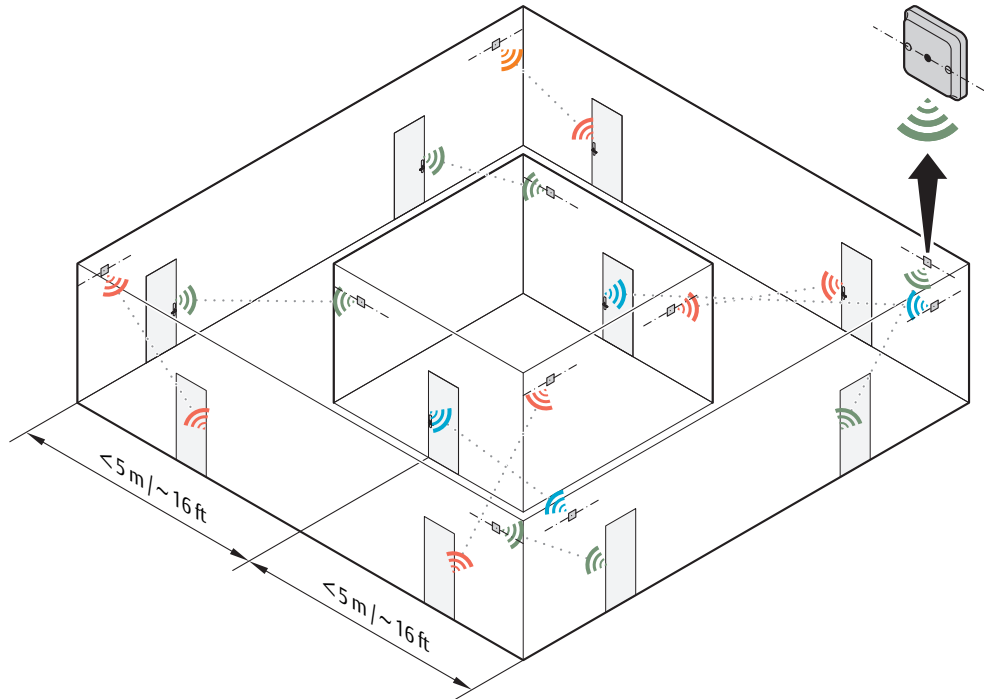

Alternate installation with ceiling placement:

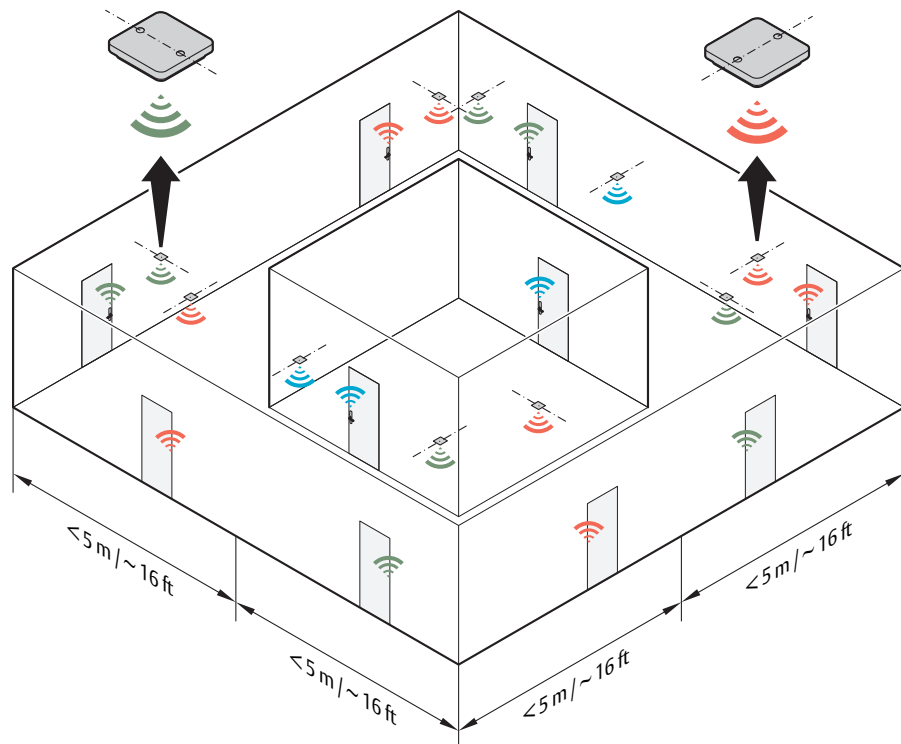

Open space environments

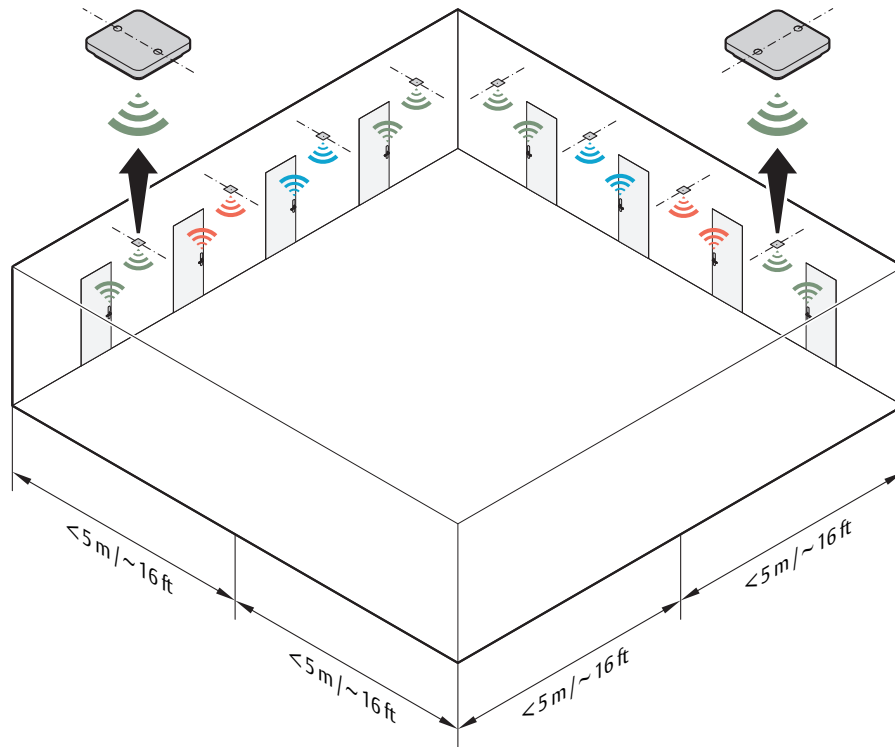

Placement options for AH15 when using other locks

When using non-cylinder locks, for example Escutcheon locks, it is recommended that the AH15 is mounted on any of the walls, and within a 5 meters (16 feet) range from the lock in the zone shown in the figure. Placement in the roof is not recommended.

It is important that the communication hub is mounted with the mounting holes vertically aligned and as close to the lock as possible.

The following pages shows typical installations based on field experience that will give a good result for radio link quality. The colors indicate which hubs and Aperio door locks that belong together.

The AH15 communication hub can be mounted according to the following figure.

	AH15 Communication hub installed on a wall, with mounting holes according to marks.
	Door with Aperio lock

Figure 5. Placement options for AH15 with other locks



i Communication hubs should always be installed on the wall when using **non** e-cylinder locks. Always align the mounting holes vertically when fastening.

Installation examples for AH15 communication hub with other type of locks

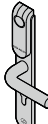
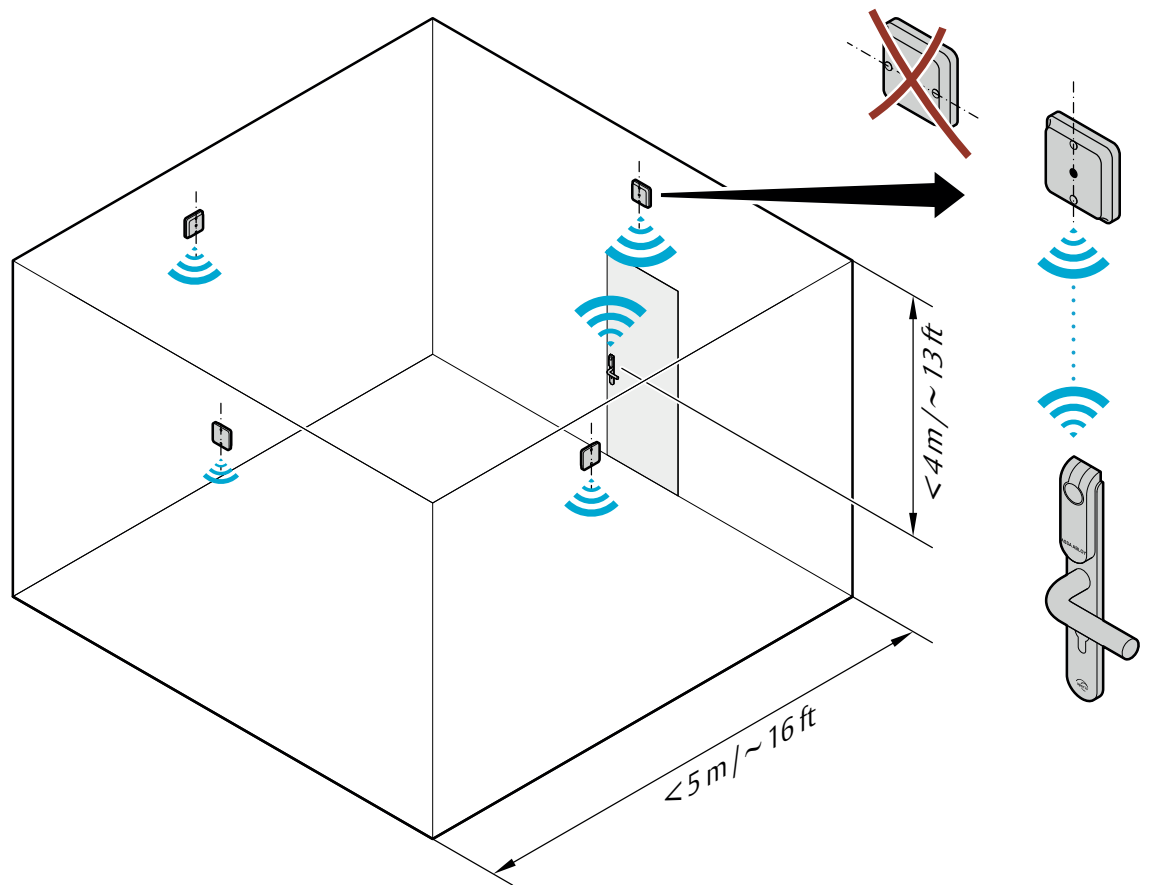
Corridors

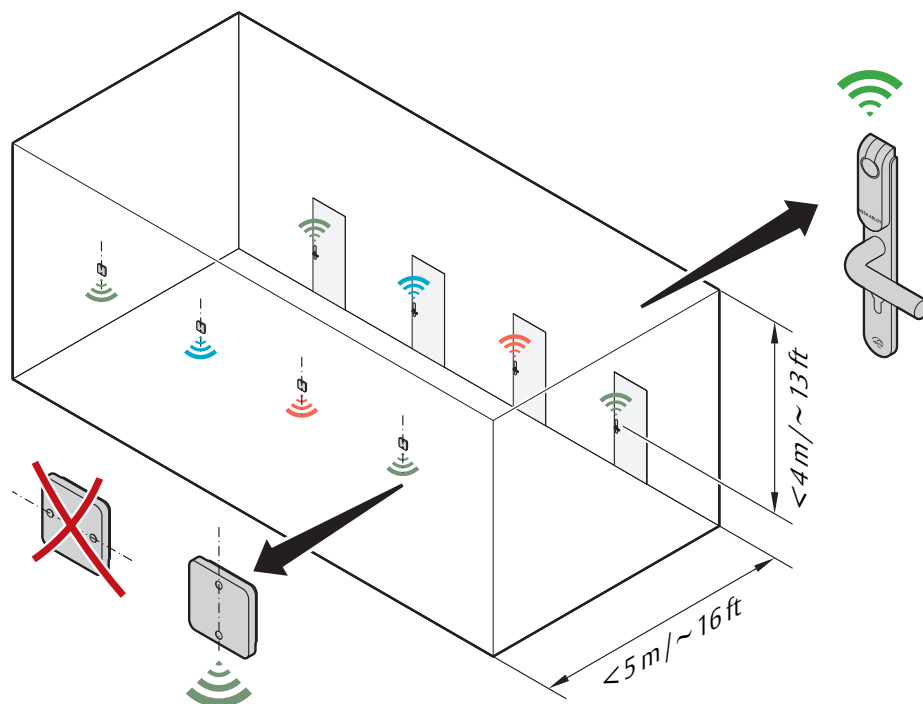

Alternate installation, on same wall:

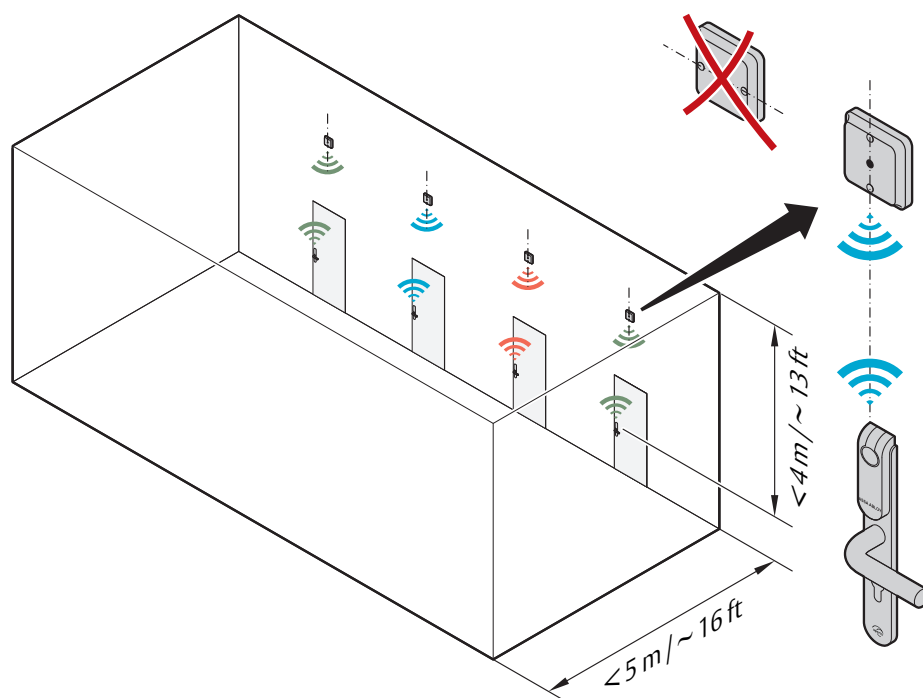

Square rooms

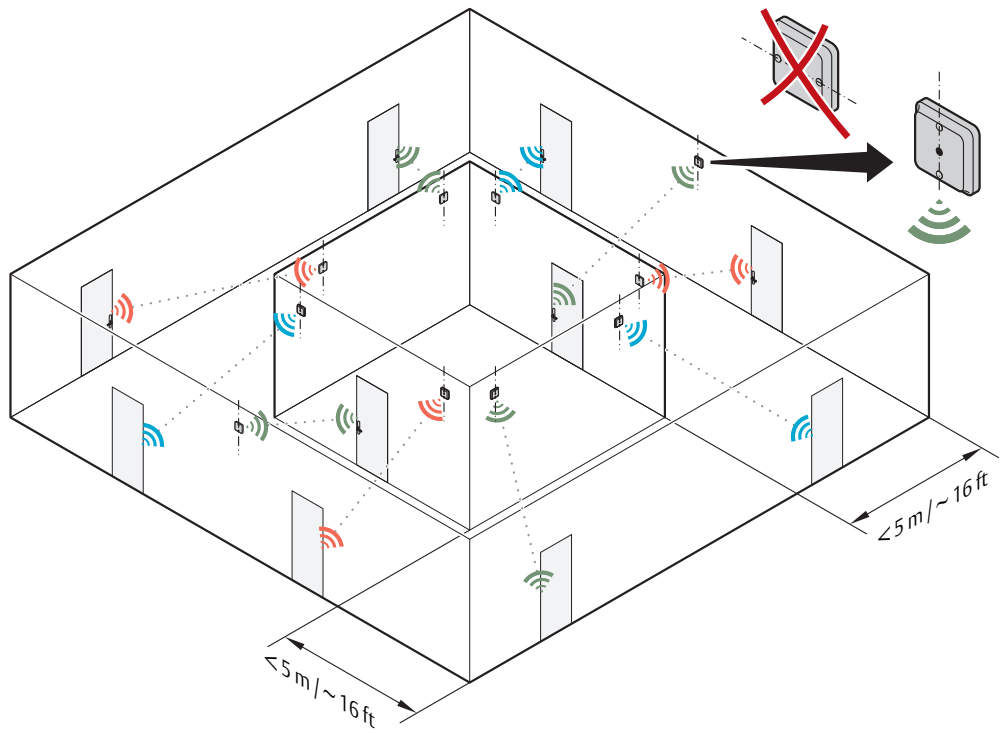

Alternate installation on same wall:

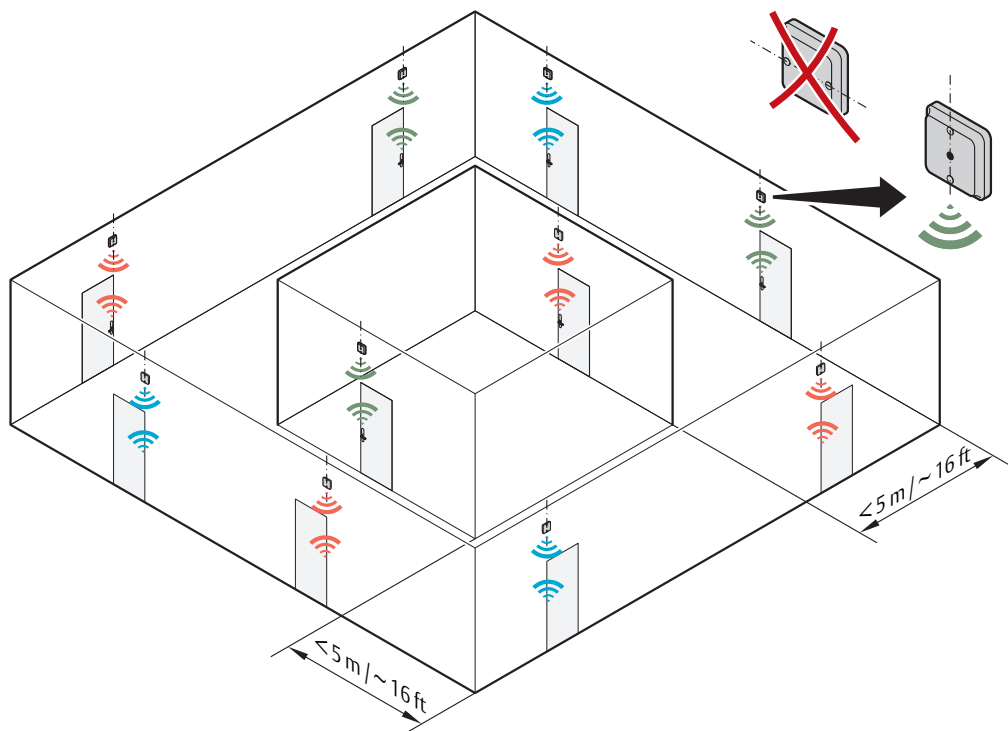

Open space environments

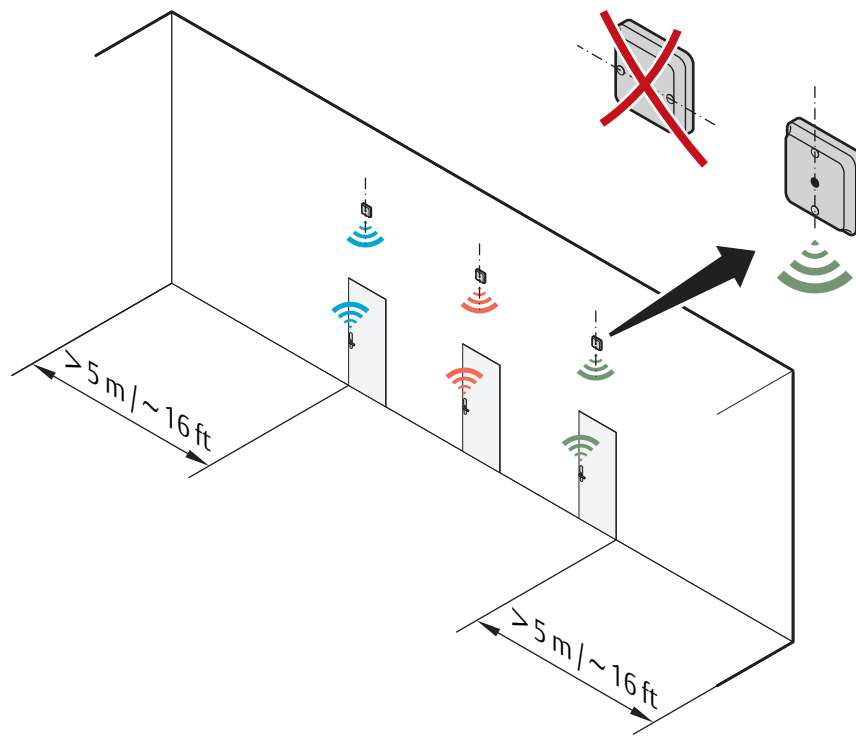

Mechanical installation AH20/30/40

Placement options for AH20/30/40

The AH20/30/40 communication hub is designed so that it can establish a reliable radio link regardless of the mounting position (horizontal or vertical) of the communication hub and the type of lock being used.

It is recommended that the distance between the lock and the communication hub is limited to **15-25 meters**, depending on the environment. However, under good conditions (free air between the units and limited radio interference from other transmitters) the distance can be extended.

The following pages shows typical installations based on field experience that will give a good result for radio link quality. The colors indicate which hubs and Aperio door locks that belong together.

The AH20/30/40 communication hub can be mounted according to the following figure.





	AH20/30/40 Communication hub with internal antenna, installed on a wall.
	AH20/30/40 Communication hub with internal antenna, installed in the ceiling.
	AH20/30/40 Communication hub with external antenna, installed in the ceiling.
	Door with Aperio lock

Figure 6.
Placement options for
AH20/30/40 communi-
cation hub

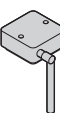

Radio coverage for external antenna

The general guideline for using an external antenna is to obtain radio coverage in a even globe around the external antenna. Note that the external antenna does not extend the maximum range, which is still 15-25 m totally.

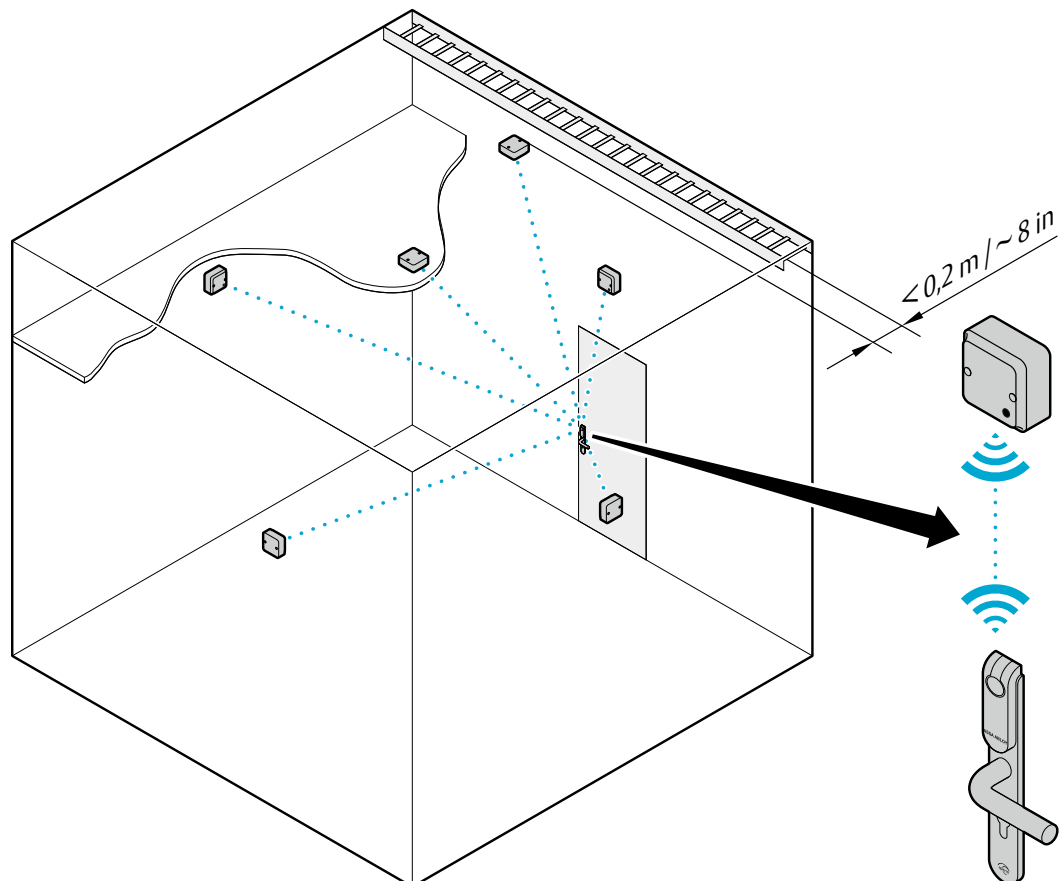
The following figure illustrates the difference in radio pattern for external and internal antenna. (Note that this is only an simplified picture of the radio reception for each antenna, showing the theoretical characteristics. The real radio coverage also vary for each installation site.)

An example of a situation where external antenna could be used is when the placement options are limited for the communication hub.

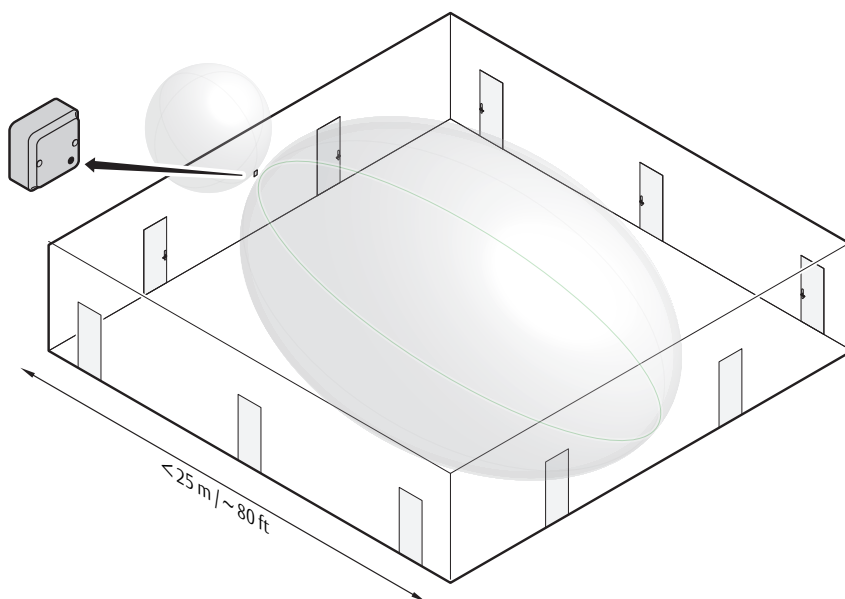
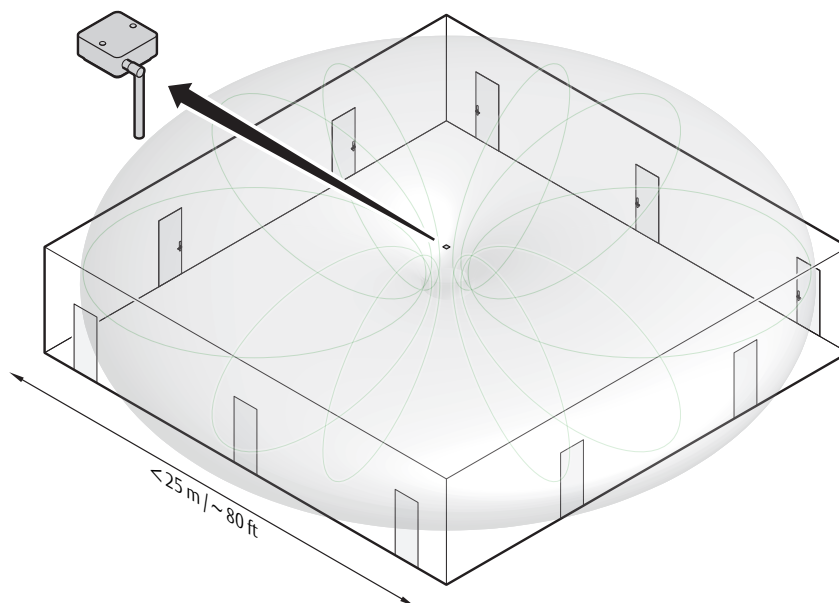

Installation examples for AH20/30/40 communication hub

Short Corridors

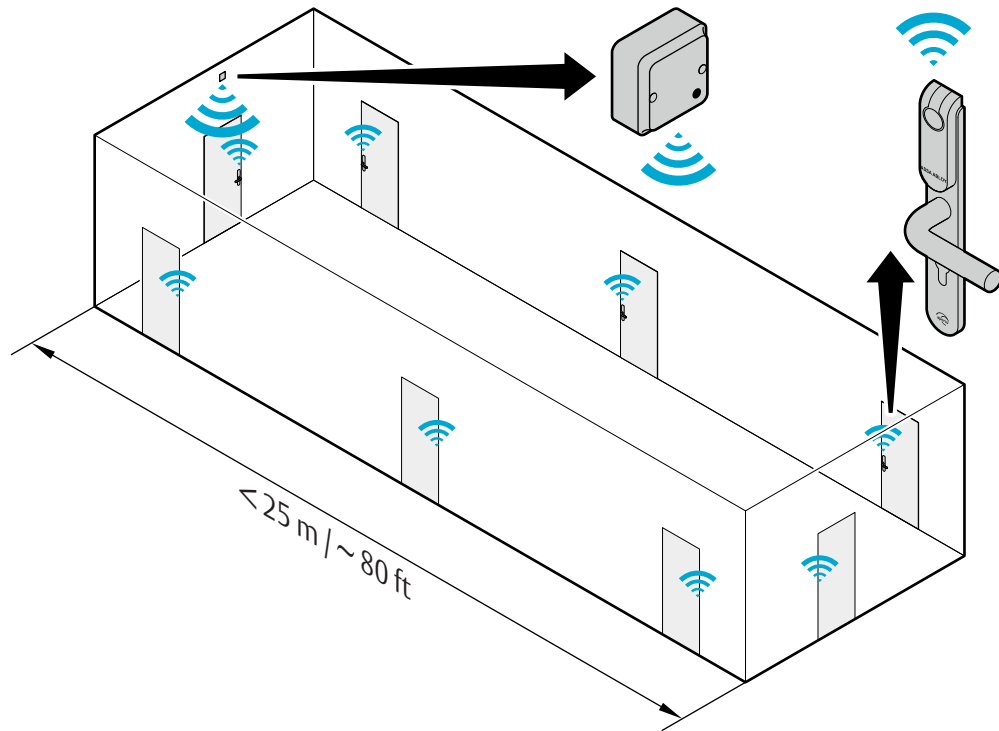

Alternate installation:

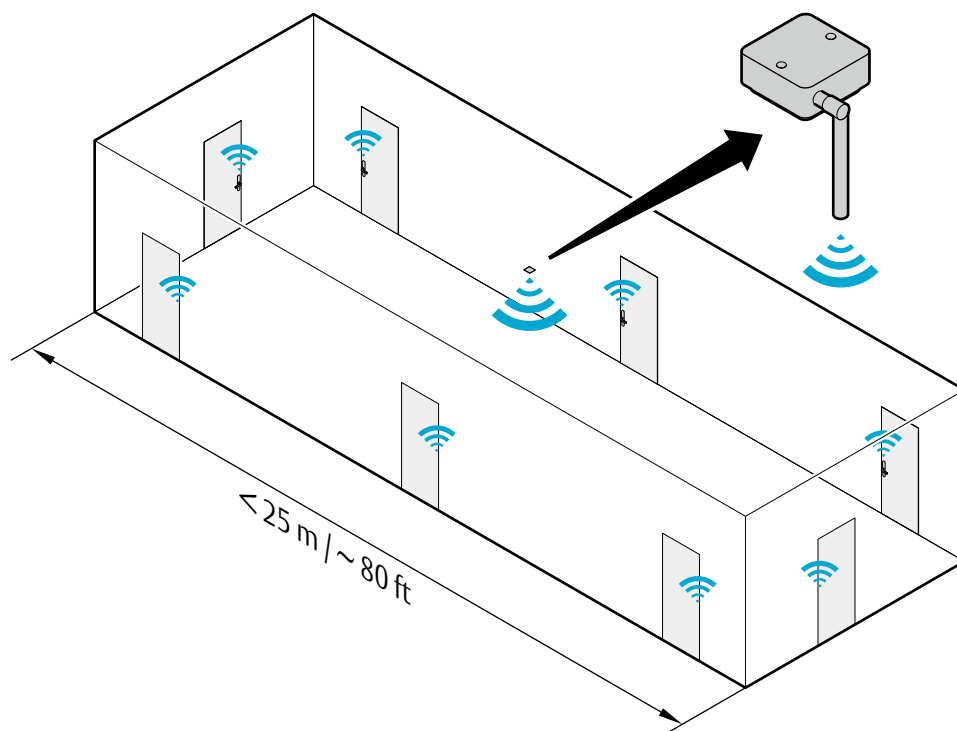

Long corridors

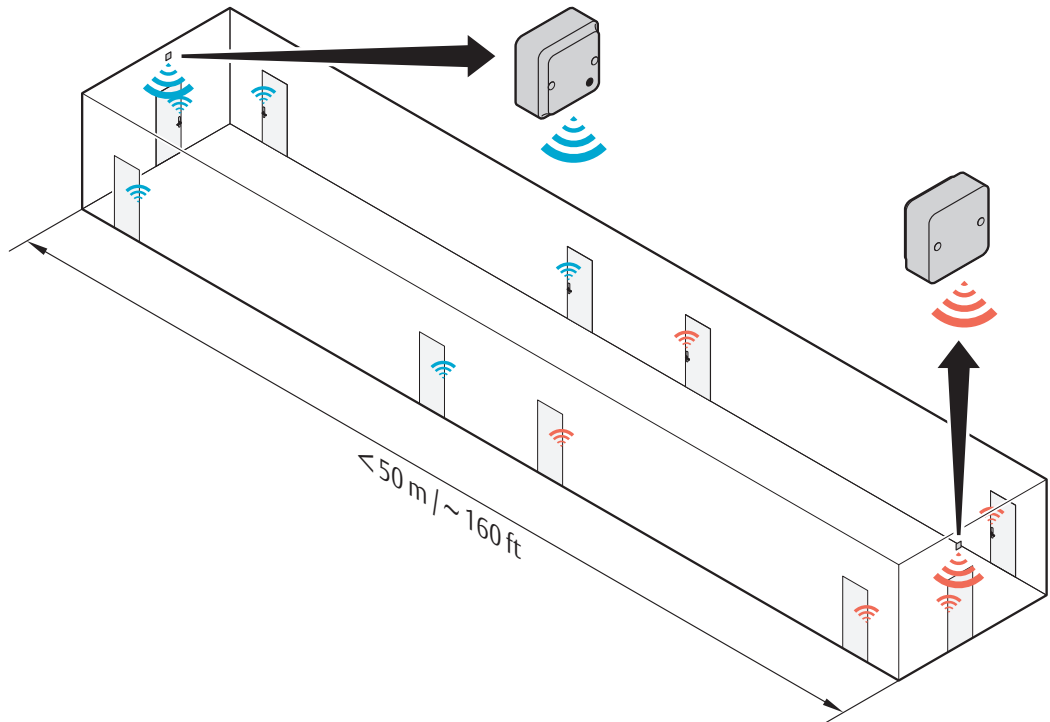

Alternate installation:

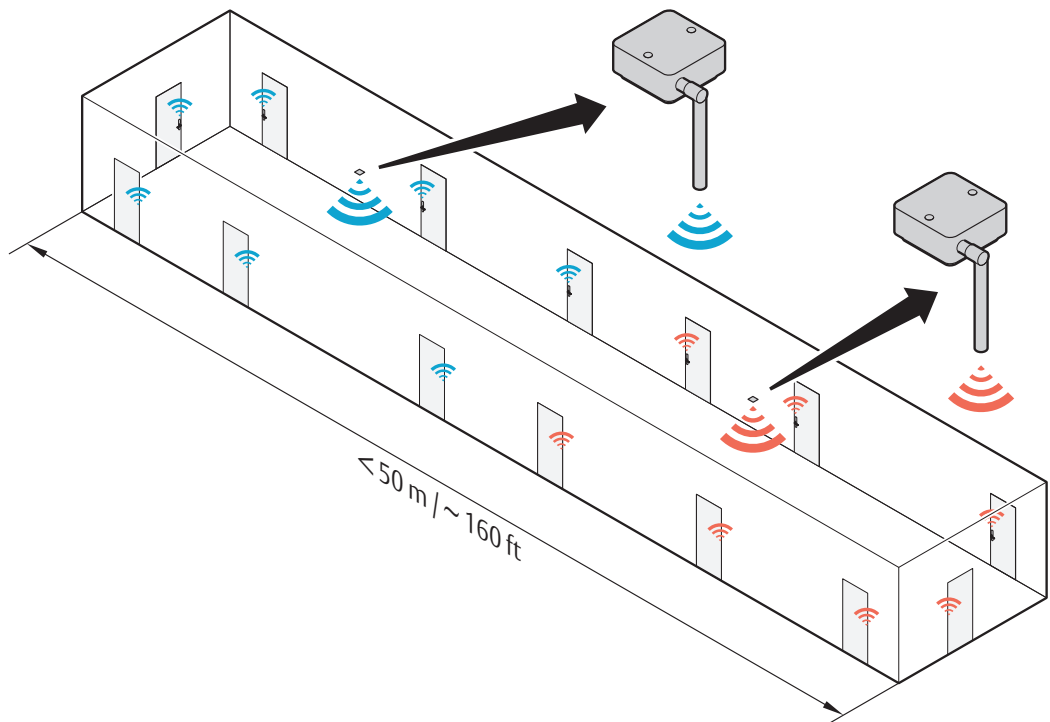

High ceiling

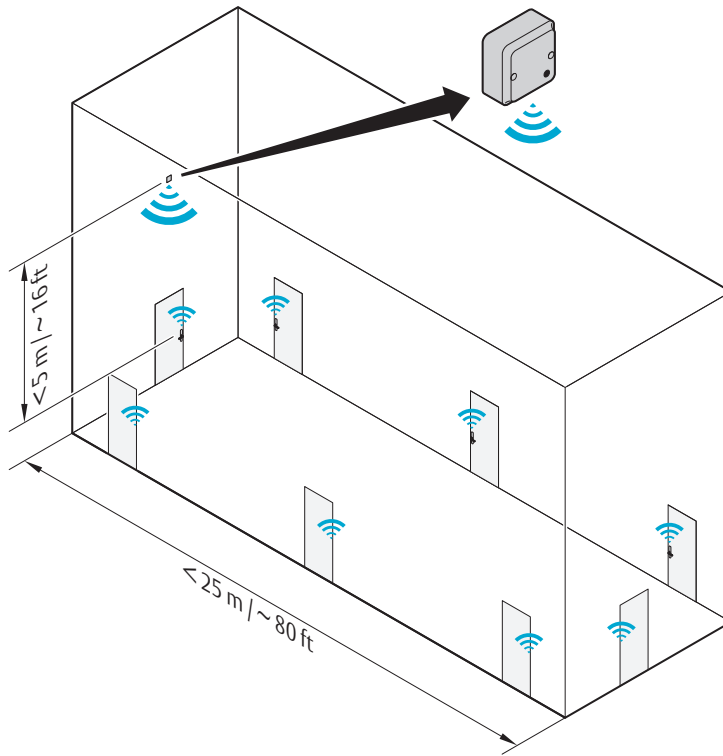

Alternate installation:

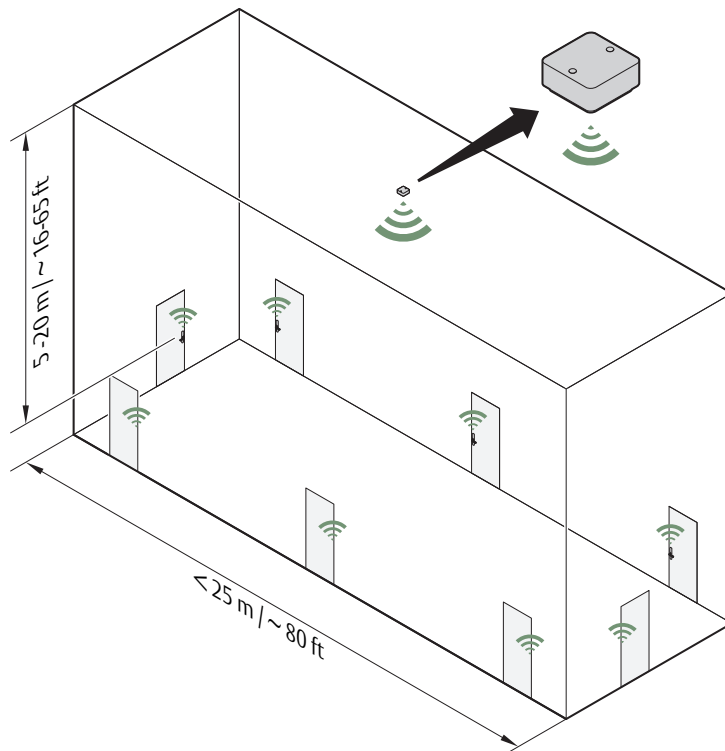

Low ceiling

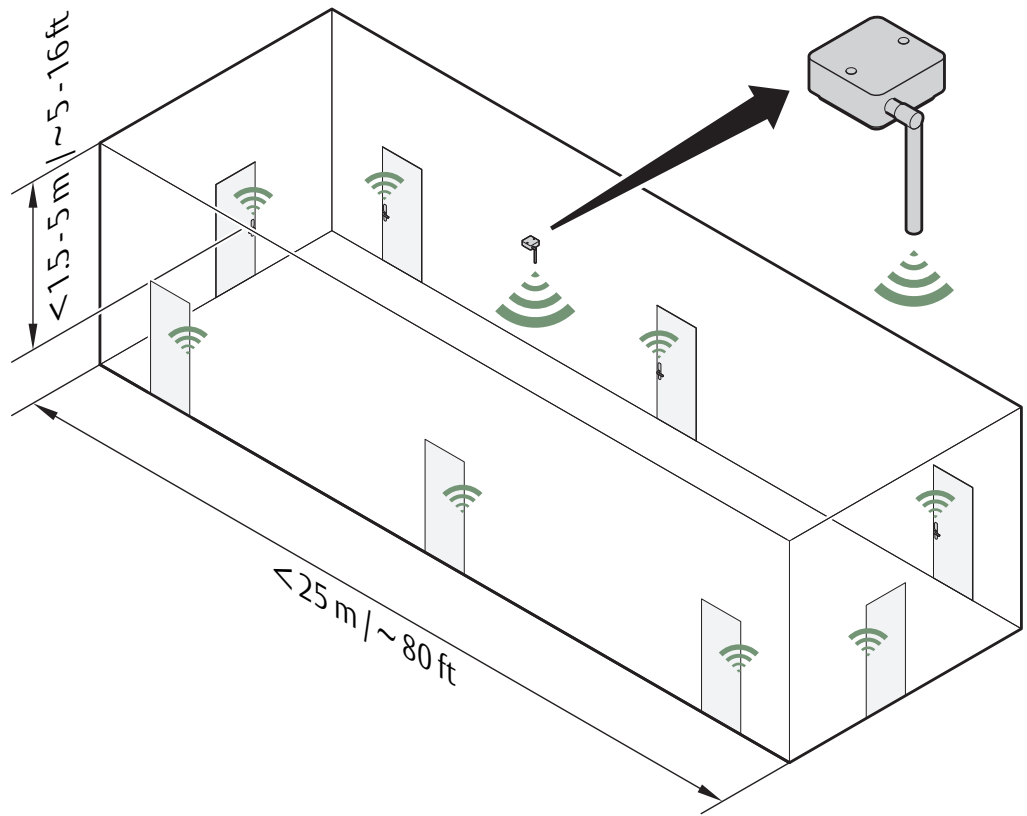

Square rooms

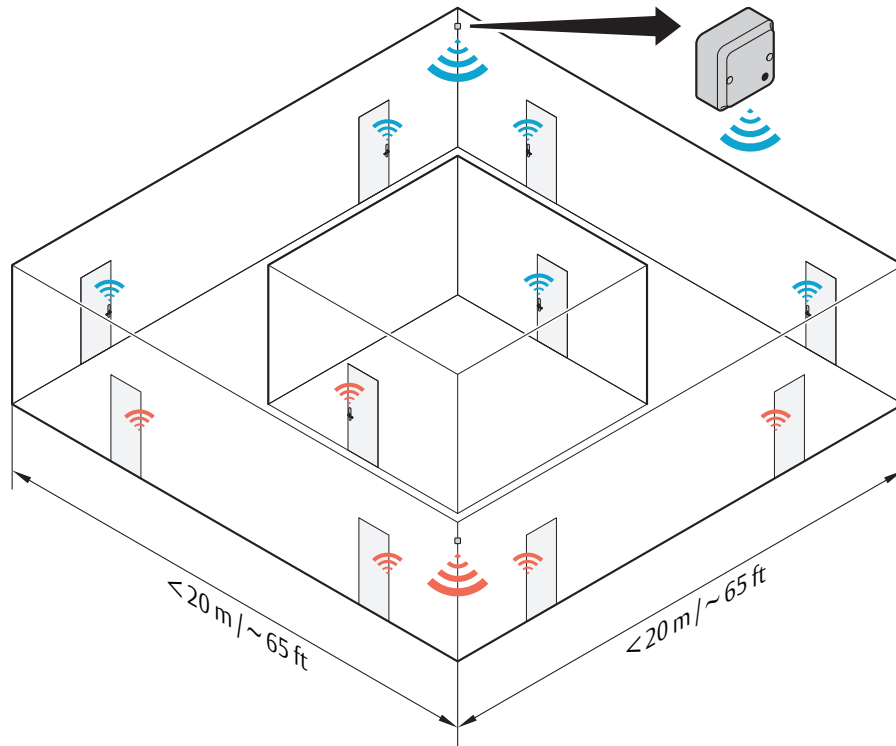

Alternate installation with "light" wall material:

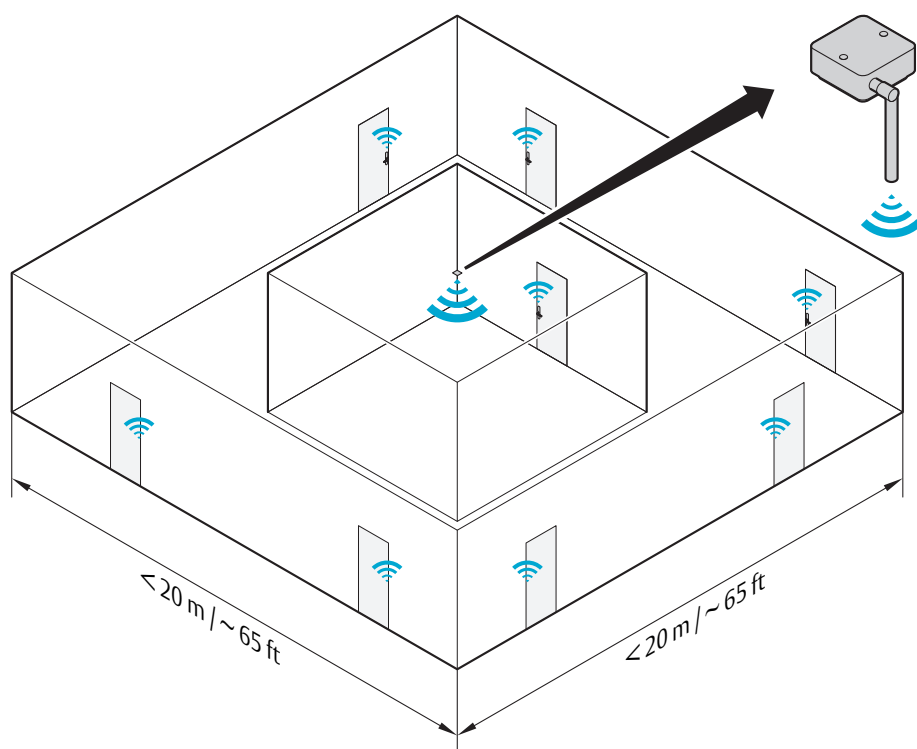

Open space environments

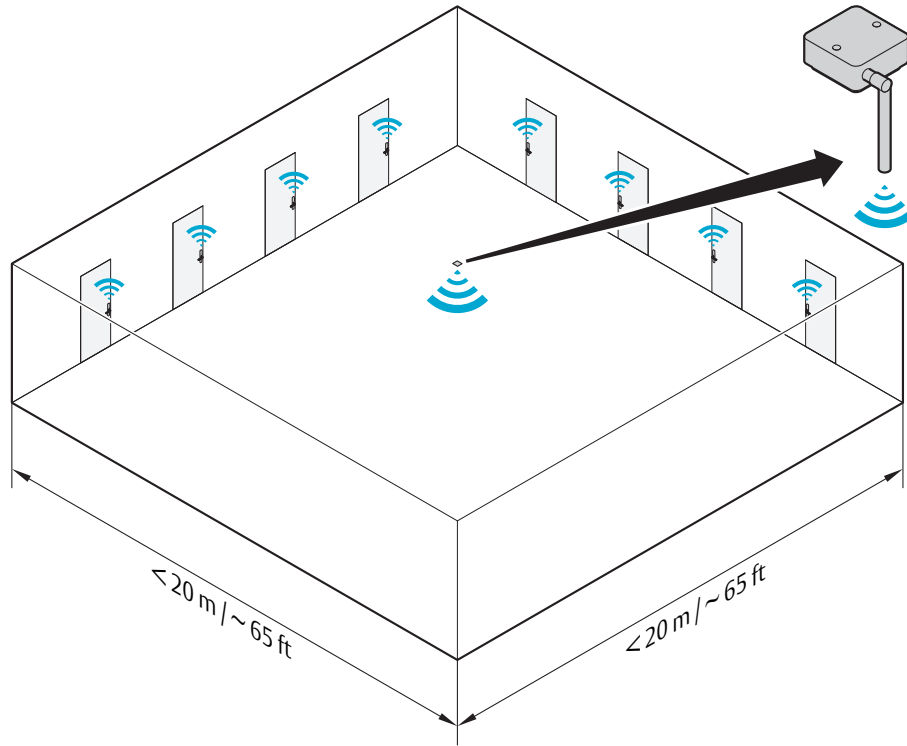

Alternate installation:

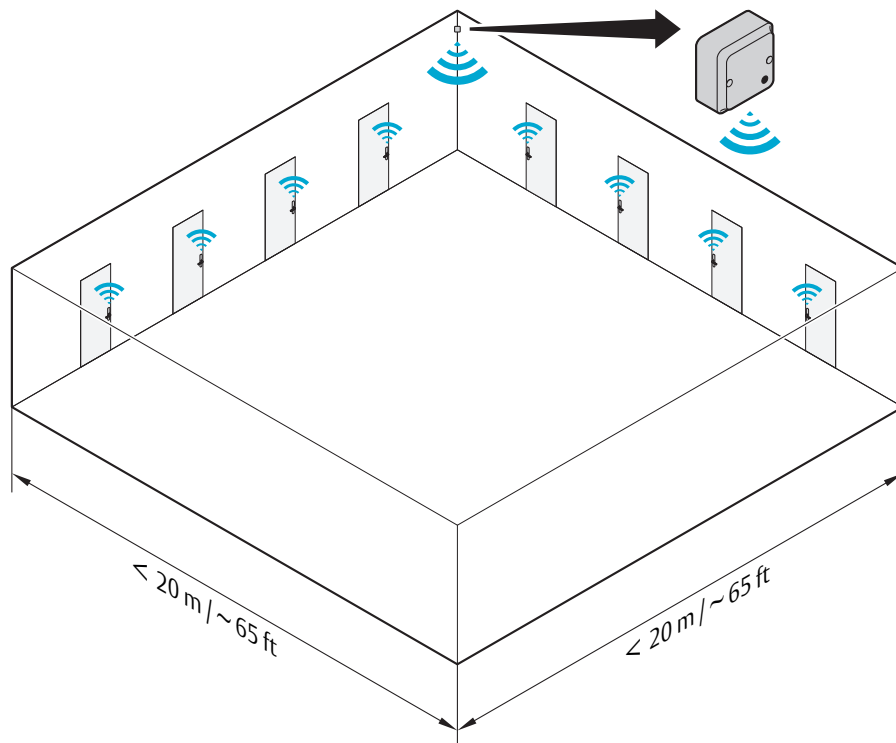

5 Configuration and Connection of Cables

AH15 (RS-485)

This chapter describes how to perform a default configuration of an AH15 communication hub using the RS-485 interface. Configuration of the communication hub to the EAC includes setting the DIP switches, connecting it to the RS-485 bus and connecting it to power supply, according to the applicable section below.

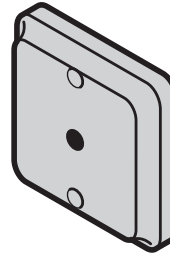

Configuring the DIP switches

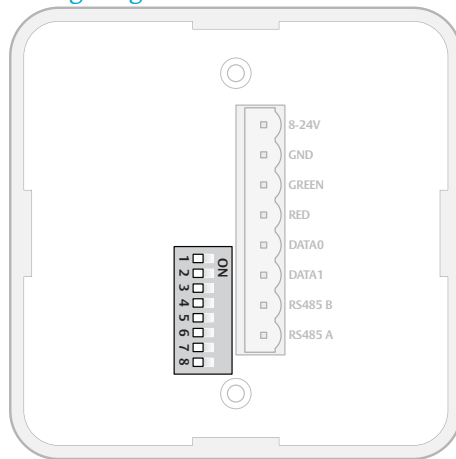

DIP	Abbr.	Description
8	TERM	Activates termination of EAC bus
7	UP	Activation of pull up resistor
6	DOWN	Activation of pull down resistor
5	A4	Manual EAC Address
4	A3	Manual EAC Address
3	A2	Manual EAC Address
2	A1	Manual EAC Address
1	A0	Manual EAC Address/Automatic pairing (DIP 1-5 = OFF)

DIP 1-5 – Selecting the EAC address/Automatic pairing

The DIP 1-5 has two functions, either automatic pairing mode, or manual selection of EAC address on the RS485. Default configuration is to select an address according to below. By doing so automatic pairing will be deactivated.

• DIP 1-5 – Pairing mode

If DIP 1-5 are set to OFF, pairing mode will be activated. This means that after powering on the communication hub it will automatically try to pair with locks within range. Automatic pairing will only be made with unpaired locks. The automatic pairing procedure is described in ref [2], Aperio Online Programming Application manual.

• DIP 1-5 – Selecting EAC address

It is possible to select an address 1-31 for the AH15 communication hub using the DIP switch. For mixed modes, see section "Selecting the correct EAC address (AH15/AH30)" on page 42 for more details and advance options.



The communication hub must be re-started after changing the address, since the state of the DIP switch is read only at startup.

Figure 7. Address allocation in a default installation

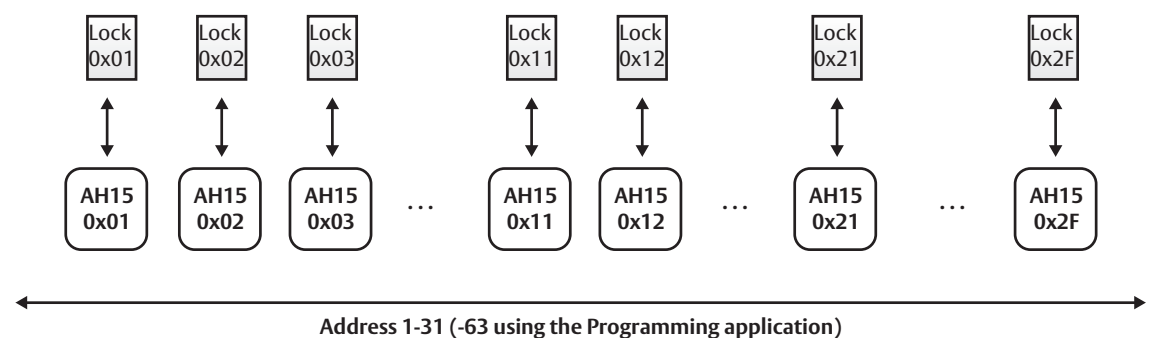

DIP 6-8 – RS-485 bus settings

DIP switch 6 and 7 activate pull up and pull down-resistors, which must be enabled once per bus. Either in the EAC system (see the EAC documentation for the EAC in use, for use of pull up or pull down on the EAC side), or on one communication hub on the RS-485-bus.

DIP 8 is used to terminate the bus, which is activated for communication hubs connected in end position on the bus.

If there is more than one communication hub to connect they should be connected in a daisy chain. In this case, set DIP switches 6-8 in OFF position for all communication hubs, except for the communication hub at the end of the bus which must have DIP switch 8 in ON position. The RS-485 bus must be terminated on the EAC side.

Figure 8. Daisy chain connected communication hubs, set DIP 6 and 7 in ON position for one communication hub

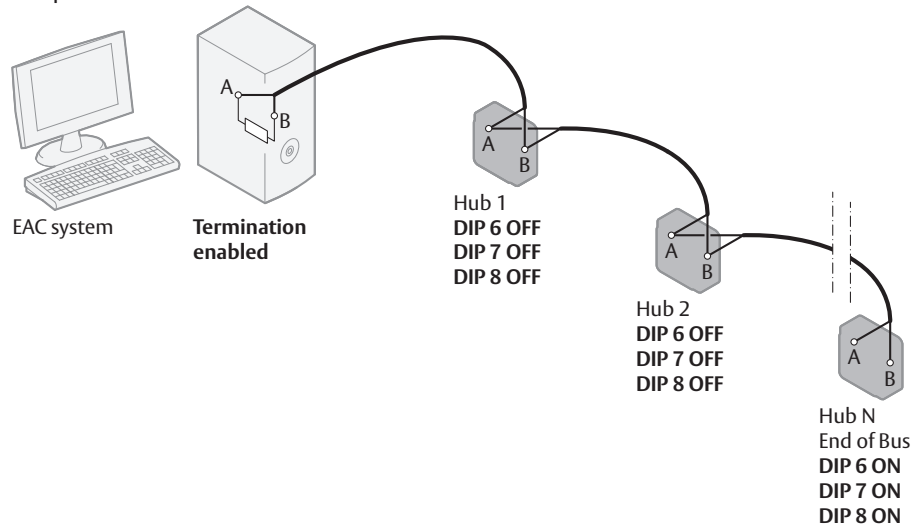

For a star connection, set DIP 6 and 7 in ON position for one communication hub. DIP 8 must be in ON position for all communication hubs. The RS-485 bus can not be terminated on the EAC side.

Figure 9. Star connected communication hubs, DIP 6 and 7 in ON position for one communication hub

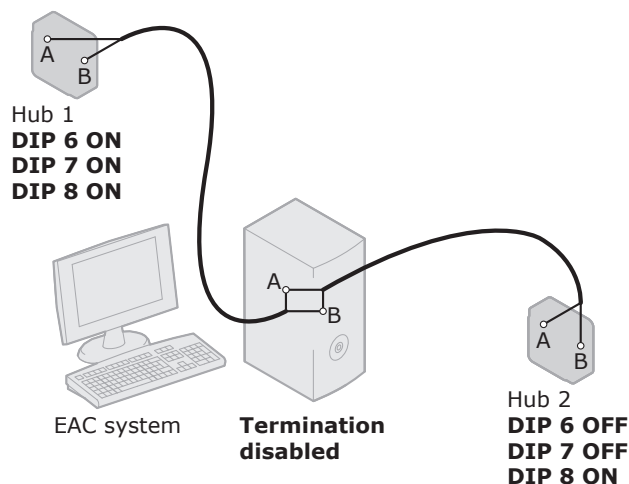

Connecting to the RS-485 bus

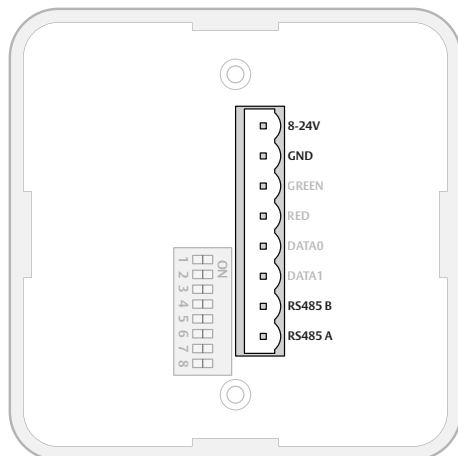

The RS-485 bus should be made up of a twisted-pair cable with characteristic impedance between 90 Ohm and 120 Ohm. Maximum bus length is about 1000 m. Depending on the EAC system, a maximum of 32 units (31 communication hubs plus the EAC, when using the DIP Switch for RS-485-addressing) can be connected to the same bus.

Connect all RS485 A connectors together and all RS485 B connectors together, depending on connection type, see *Figure 8* and *Figure 9* on page 26.

Connecting to supply voltage

Connect the wires to 8-24 VDC, 0.9 W and GND (ground) on the communication hub.

Note! The power supply shall be a Limited Power Source (LPS) according to EN 60950-1. The power supply shall be 3 A over current protected. Wire requirements 16-22 AWG.

AH15 (Wiegand)

Configuring and connecting the AH15 communication hub to the EAC includes setting the DIP switches, connecting it to the Wiegand interface bus and connecting it to power supply, according to the applicable section below.

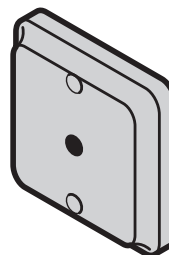

Configuring the DIP switches

Details for the Wiegand interface signals:

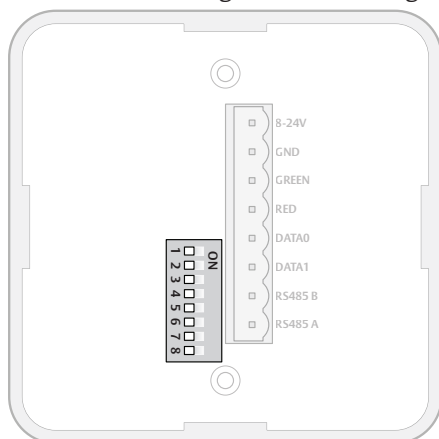

DIP	Abbr.	Description
8	TERM	Not applicable for Wiegand. Set to OFF.
7	UP	Not applicable for Wiegand. Set to OFF.
6	DOWN	Not applicable for Wiegand. Set to OFF.
5	A4	ON = Starts in pairing mode. OFF = Normal use.
4	A3	Controls byte order of transmitted credentials. OFF => The byte order is left as is. ON => The byte order is reversed compared to what is received as input to the Hub Wiegand EAC interface component.
3	A2	Controls addition of parity bits on transmitted credentials. One even parity bit before and one odd parity bit after the actual credentials. OFF => Addition of parity is disabled. Credentials are transmitted as received. ON => Addition of parity bits is enabled.
2	A1	Reserved for future use. Set to OFF.
1	A0	Controls use of Red LED signal for access decision. ON = Red LED is used. OFF = Red LED is ignored.

Default configuration

According to the figure, all DIP switches in position OFF on the communication hub give a default Wiegand configuration that will fit most EAC systems. However, customizing the configuration can result in better performance.

DIP 1 - Selecting LED input signals and access decision

If the EAC system can send a signal that actively asserts an access denied decision (Red LED), DIP 1 should be set to ON. This will give:

- Shorter response time at a denied access.
 - Possibility to use override credentials in the lock.
- The flowcharts below explain how the LED input signals are used to derive an access decision. The OFF and ON variants are depicted. '

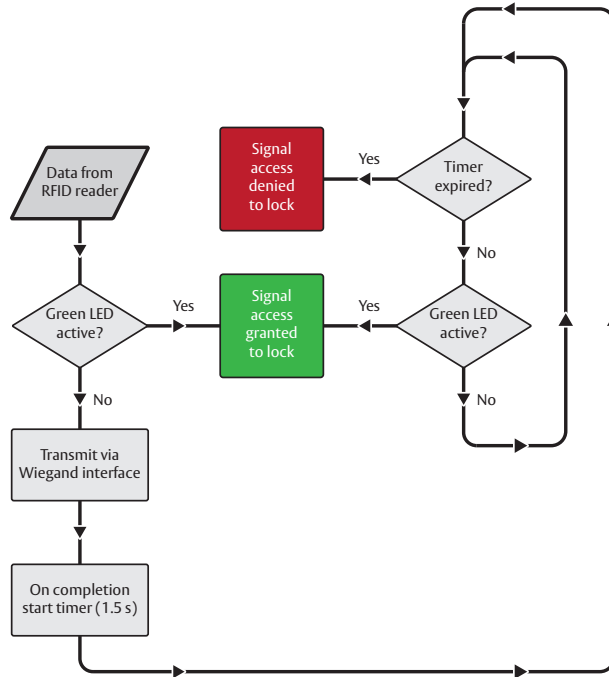

Figure 10. Dip Switch 1 – OFF: Access decision logic with single LED signal

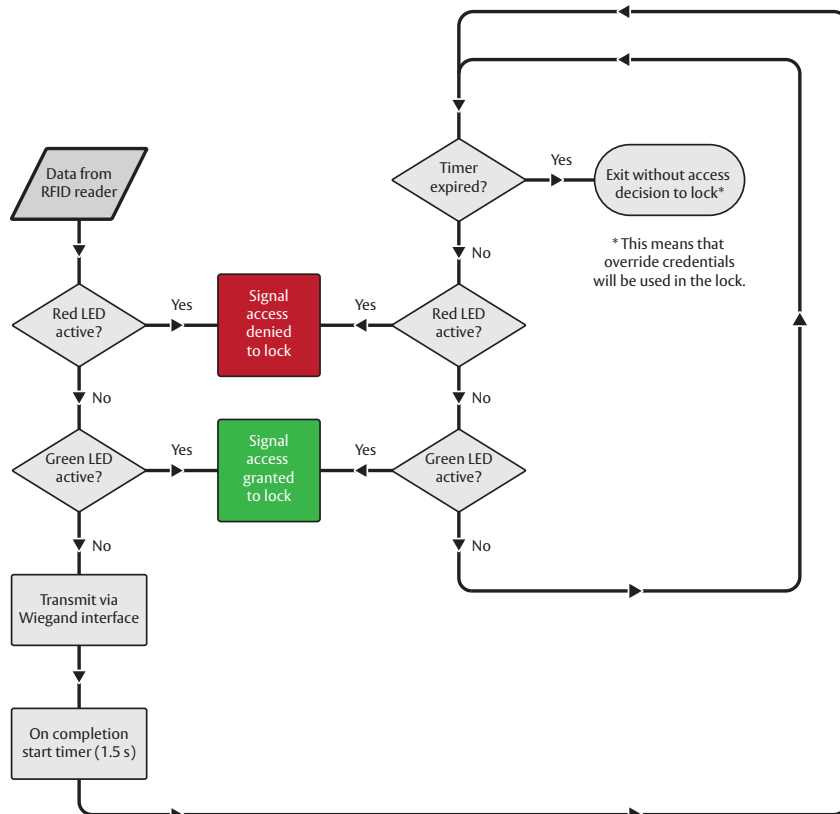

Figure 11. Dip Switch 1 – ON: Access decision logic with two LED signals



If the EAC system is using output signal Red LED for other purposes than to control the lock, then this signal should not be connected to the communication hub. Set DIP switch 1 in position OFF in this case

If the EAC system is using output signal Green LED for other purposes than to control the lock, then this signal should not be connected to the communication hub. Use a lock relay output or another similar lock control output from the EAC system instead.

Use of override credential is not possible combined if DIP switch 1 in position OFF. The reason is that the Hub produces an “access denied” decision based on time out in this case.

DIP 2 (Future use)

Note! This DIP must always be set to OFF.

DIP 3 - Parity bit

Note! Transmitted credentials may include parity also if addition of parity is disabled in the Hub Wiegand EAC interface component. This, since parity bits, if used, typically are included already on the credential.

DIP 4 - Byte Order

Note! This setting is ignored if the credential length does not make up complete bytes. Note! The byte order received as input to the Hub Wiegand EAC interface component in the case of a 32 bit MIFARE UID credential is UID[3], UID[2], UID[1], UID[0]. This means that the byte order is already reversed earlier in the chain compared to the order specified in RFID interface standard ISO 14443-3.

DIP 5 - Pairing mode

If DIP switch 5 is set to ON, pairing mode will be activated. This means that after powering on the communication hub it will automatically try to pair with locks within reach. Automatic pairing will only be made with unpaired locks. See ref [2] Aperio Online Programming Application manual for instructions on how to perform the pairing.

Connecting to the Wiegand bus

The AH15 communication hub has four Wiegand signals plus ground. Purpose and connection of these signals are described in the table below.

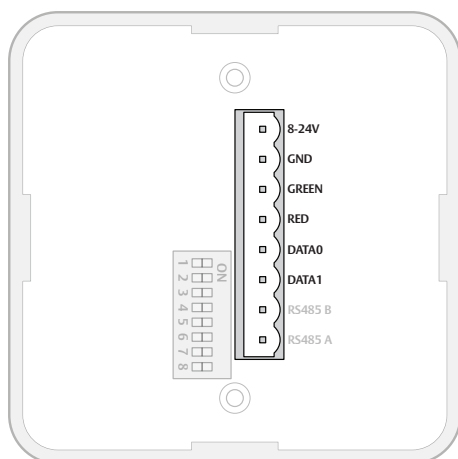

Hub connector designation	Description	Connect to...
8-24V	Positive voltage	EAC power supply
GND	Ground	EAC system ground.
GREEN	Wiegand Green LED signal. Input to communication hub. Used for access decision.	Wiegand Green LED output on EAC system. Alternatively, connect to a lock control relay output on EAC system.
RED	Wiegand Red LED signal. Input to communication hub. Used for access decision.	Wiegand Red LED output on EAC system. Alternatively, leave unconnected if signal is selected not to be used by DIP switch 1.
DATA0	Wiegand Data 0 signal. Output from communication hub. Used to transmit credentials.	Wiegand Data 0 on EAC system.
DATA1	Wiegand Data 1 signal. Output from communication hub. Used to transmit credentials.	Wiegand Data 1 on EAC system.
RS485 B	NOT APPLICABLE	-
RS485 A	NOT APPLICABLE	-

Connecting to supply voltage

Connect the wires to 8-24 VDC, 0.9 W and GND (ground) on the communication hub.

Note! The power supply shall be a Limited Power Source (LPS) according to EN 60950-1. The power supply shall be 3 A over current protected. Wire requirements 16-22 AWG.

AH20 (Wiegand)

Configuring and connecting the communication hub to the EAC includes setting the DIP switches, connecting it to the Wiegand interface bus and connecting it to power supply, according to the applicable section below.

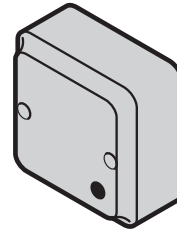

Configuring the DIP switch

Details for the Wiegand interface signals:

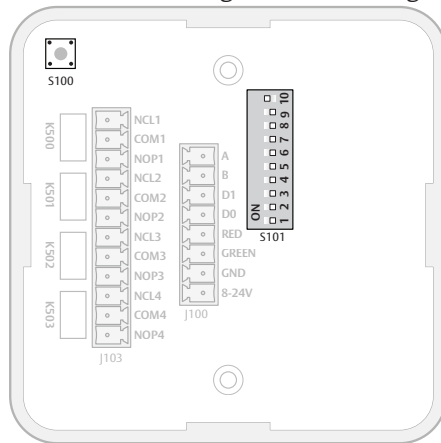

Default configuration

According to the figure, DIP switches 1-9 in position OFF and DIP switch 10 in ON (Internal antenna) on the communication hub will give a default Wiegand configuration that will fit most EAC systems. However, customizing the configuration can result in better performance.

DIP 1 - Selecting LED input signals and access decision

If the EAC system can send a signal that actively asserts an access denied decision (Red LED), DIP 1 should be set to ON.

This will give:

- Shorter response time at a denied access.
- Possibility to use override credentials in the lock.

The flowcharts below explain how the LED input signals are used to derive an access decision. The OFF and ON variants are depicted.

DIP	Abbr.	Description
10	INT/EXT	Internal/external antenna
9		Not used
8	TERM	Not applicable for Wiegand. Set to OFF.
7	UP	Not applicable for Wiegand. Set to OFF.
6	DOWN	Not applicable for Wiegand. Set to OFF.
5	A4	ON = Starts in pairing mode. OFF = Normal use.
4	A3	Controls byte order of transmitted credentials. OFF => The byte order is left as is. ON => The byte order is reversed compared to what is received as input to the Hub Wiegand EAC interface component.
3	A2	Controls addition of parity bits on transmitted credentials. One even parity bit before and one odd parity bit after the actual credentials. OFF => Addition of parity is disabled. Credentials are transmitted as received. ON => Addition of parity bits is enabled.
2	A1	Set to OFF. Reserved for future use.
1	A0	Controls use of Red LED signal for access decision. ON = Red LED is used. OFF = Red LED is ignored.

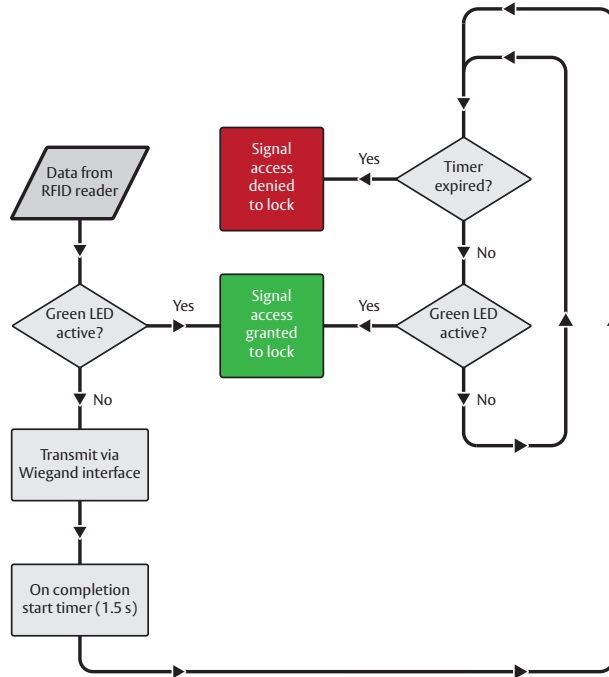

Figure 13. Dip Switch 1 – OFF: Access decision logic with single LED signal

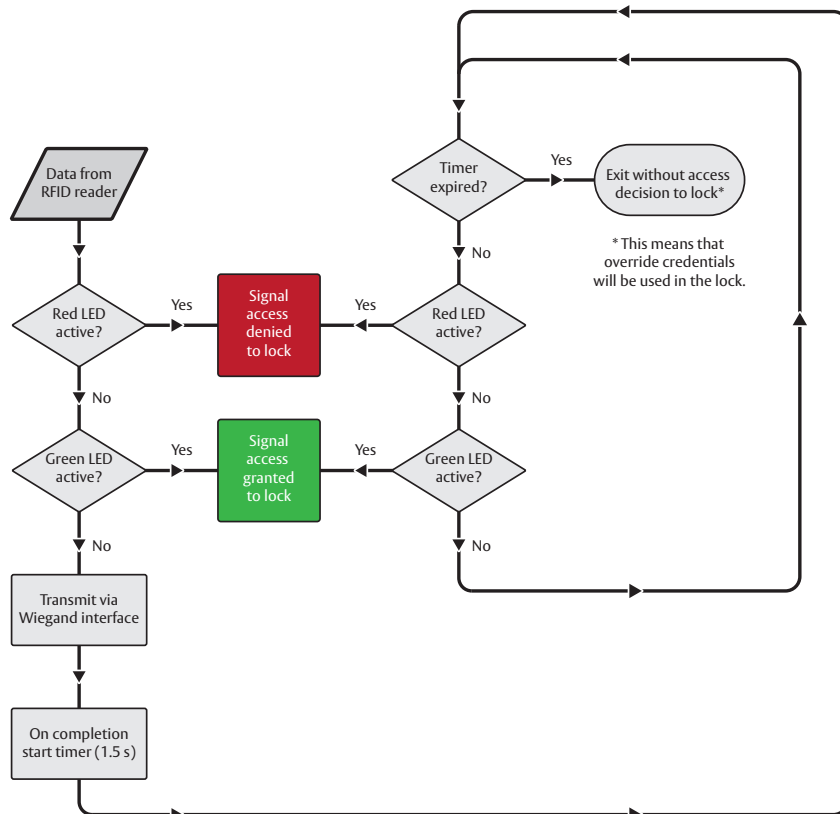

Figure 14. Dip Switch 1 – ON: Access decision logic with two LED signals



The communication hub must be restarted after any changes on the DIP switch, since the state of the DIP switch is read only at startup. If the EAC system is using output signal Red LED for other purposes than to control the lock, then this signal should not be connected to the communication hub. Set DIP switch 1 in position OFF in this case.

If the EAC system is using output signal Green LED for other purposes than to control the lock, then this signal should not be connected to the communication hub. Use a lock relay output or another similar lock control output from the EAC system instead.

Use of override credential is not possible if DIP switch 1 is in position OFF. The reason is that the communication hub produces an “access denied” decision based on time out in this case.

DIP 2 (Future use)

Note! This DIP must always be set to OFF.

DIP 3 - Parity bit

Note! Transmitted credentials may include parity also if addition of parity is disabled in the Hub Wiegand EAC interface component. This since parity bits, if used, typically are included already on the credential.

DIP 4 - Byte Order

Note! This setting is ignored if the credential length does not make up complete bytes. Note! The byte order received as input to the Hub Wiegand EAC interface component in the case of a 32 bit MIFARE UID credential is UID[3], UID[2], UID[1], UID[0]. This means that the byte order is already reversed earlier in the chain compared to the order specified in RFID interface standard ISO 14443-3.

DIP 5 - Pairing mode

If DIP switch 5 is set to ON, pairing mode will be activated. This means that after powering the communication hub it will automatically try to pair with locks within reach. Automatic pairing will only be made with unpaired locks. See ref [2] Aperio Online Programming Application manual for instructions on how to perform the pairing.

Connecting to the Wiegand bus

The AH20 communication hub has four Wiegand signals plus ground. Purpose and connection of these signals are described in the table below.

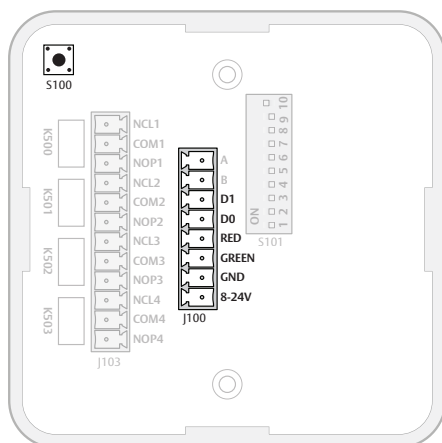

Hub connector designation	Description	Connect to...
A	NOT APPLICABLE	-
B	NOT APPLICABLE	-
DATA1	Wiegand Data 1 signal. Output from communication hub. Used to transmit credentials.	Wiegand Data 1 on EAC system.
DATA0	Wiegand Data 0 signal. Output from communication hub. Used to transmit credentials.	Wiegand Data 0 on EAC system.
RED	Wiegand Red LED signal. Input to communication hub. Used for access decision.	Wiegand Red LED output on EAC system. Alternatively, leave unconnected if signal is selected not to be used by DIP switch 1.
GREEN	Wiegand Green LED signal. Input to communication hub. Used for access decision.	Wiegand Green LED output on EAC system. Alternatively, connect to a lock control relay output on EAC system.
GND	Ground	EAC system ground.
8-24V	Positive voltage	EAC power supply

Connecting the relays

The four form C relays on the AH20 version can be used by the EAC to supervise door position status, handle position, battery alarm output and tamper alarm output.

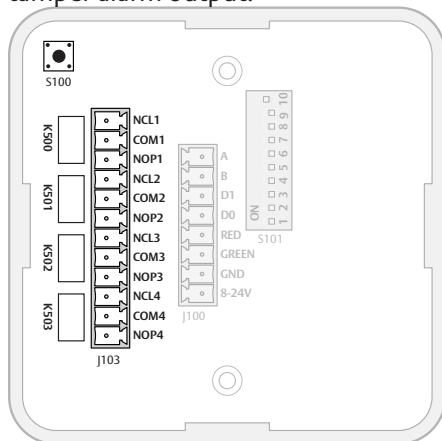

Connecting to supply voltage

Connect the wires to 8-24 VDC, 2 W and GND (ground) on the communication hub.

Note! The power supply shall be a Limited Power Source (LPS) according to EN 60950-1. The power supply shall be 3 A over current protected. Wire requirements 16-22 AWG.

Relays	Description
Relay 1/K500	DPS (Door Position Sensor)
Relay 2/K501	RX (Request to exit)
Relay 3/K502	Battery Alarm Output
Relay 4/K503	Tamper Alarm Output/Lock Jammed
Relay Contacts	Description
NCL	Normal Closed
COM	Common
NOP	Normal Open

Relay max voltage: 30 VDC

Relay max current: 1 A resistive load

AH30 (RS-485)

This chapter describes how to perform a default configuration of an AH30 communication hub using the RS-485 interface.

Configuration of the communication hub to the EAC includes setting the DIP switches and, if not done earlier, connecting it to the RS-485 bus and to power supply, according to the applicable section below.

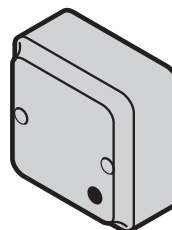

Configuring the DIP switches

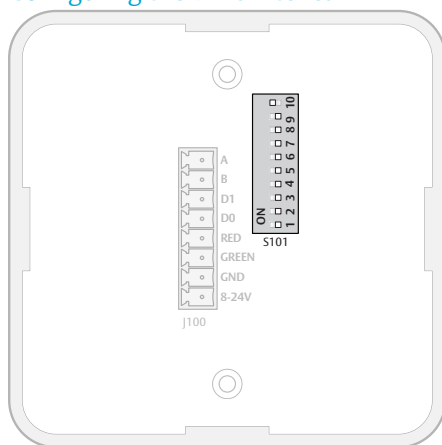

DIP	Abbr.	Description
10	INT/EXT	Internal/external antenna
9		Not used
8	TERM	Activates termination of EAC bus
7	UP	Activation of pull up resistor
6	DOWN	Activation of pull down resistor
5	A4	Manual EAC Address
4	A3	Manual EAC Address
3	A2	Manual EAC Address
2	A1	Manual EAC Address
1	A0	Manual EAC Address/Automatic pairing (DIP 1-5 = OFF)

DIP 1-5 – Selecting the EAC address/Automatic pairing

The DIP 1-5 has two functions, either automatic pairing mode, or manual selection of EAC address on the RS485. Default configuration is to select an address according to below. By doing so automatic pairing will be deactivated.

• DIP 1-5 – Pairing mode

If DIP 1-5 are set to OFF, pairing mode will be activated. This means that after powering on the communication hub it will automatically try to pair with locks within range. Automatic pairing will only be made with unpaired locks. The automatic pairing procedure is described in ref [2], Aperio Online Programming Application manual.

• DIP 1-5 – Selecting EAC address

It is possible to select an address 1-31 for the AH15 communication hub using the DIP switch. For mixed modes, see section "Selecting the correct EAC address (AH15/AH30)" on page 42 for more details and advance options.

Select a unique EAC address 1-15 for each communication hub by use of the DIP switch according to the table below. (The resulting lock addresses for each communication hub address are shown to the right):

DIP 4 – DIP 1	AH30 Hub address	Lock addresses
0000		Reserved
0001	0x01	0x01, 0x11, 0x21, 0x31, 0x41, 0x51, 0x61, 0x71
0010	0x02	0x02, 0x12, 0x22, 0x32, 0x42, 0x52, 0x62, 0x72
0011	0x03	0x03, 0x13, 0x23, 0x33, 0x43, 0x53, 0x63, 0x73
0100	0x04	0x04, 0x14, 0x24, 0x34, 0x44, 0x54, 0x64, 0x74
0101	0x05	0x05, 0x15, 0x25, 0x35, 0x45, 0x55, 0x65, 0x75
0110	0x06	0x06, 0x16, 0x26, 0x36, 0x46, 0x56, 0x66, 0x76
0111	0x07	0x07, 0x17, 0x27, 0x37, 0x47, 0x57, 0x67, 0x77
1000	0x08	0x08, 0x18, 0x28, 0x38, 0x48, 0x58, 0x68, 0x78
1001	0x09	0x09, 0x19, 0x29, 0x39, 0x49, 0x59, 0x69, 0x79
1010	0x0A	0x0A, 0x1A, 0x2A, 0x3A, 0x4A, 0x5A, 0x6A, 0x7A
1011	0x0B	0x0B, 0x1B, 0x2B, 0x3B, 0x4B, 0x5B, 0x6B, 0x7B
1100	0x0C	0x0C, 0x1C, 0x2C, 0x3C, 0x4C, 0x5C, 0x6C, 0x7C
1101	0x0D	0x0D, 0x1D, 0x2D, 0x3D, 0x4D, 0x5D, 0x6D, 0x7D
1110	0x0E	0x0E, 0x1E, 0x2E, 0x3E, 0x4E, 0x5E, 0x6E, 0x7E
1111	0x0F	0x0F, 0x1F, 0x2F, 0x3F, 0x4F, 0x5F, 0x6F, 0x7F

The following figure shows an example of a default installation.

Figure 16. Address allocation in a default installation

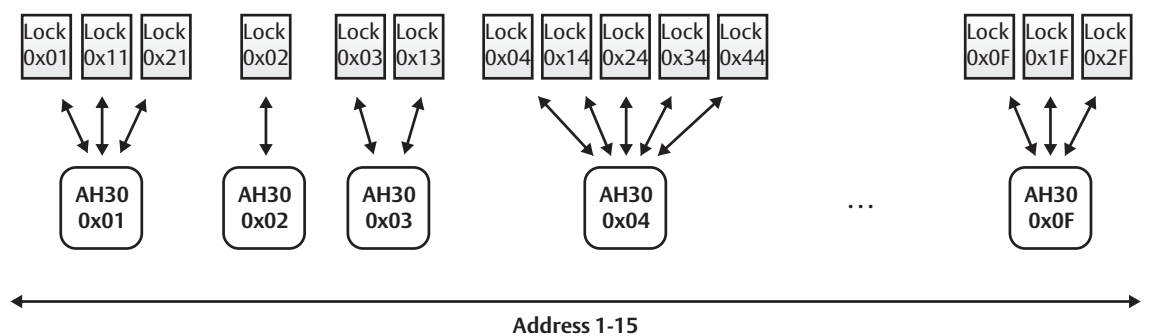

The communication hub must be re-started after changing the address, since the state of the DIP switch is read only at startup.

DIP 6-8 – RS-485 bus settings

DIP switch 6 and 7 activate pull up and pull down-resistors, which must be enabled once per bus. Either in the EAC system (see the EAC documentation for use of pull up or pull down on the EAC side), or on one communication hub on the RS-485-bus.

DIP 8 is used to terminate the bus, which is activated for the communication hub connected in end position on the bus.

If there is more than one communication hub to connect they should be connected in a daisy chain. In this case, set DIP switches 6-8 in OFF position for all communication hubs, except for the communication hub at the end of the bus which must have DIP switches 6-8 in ON position. The RS-485 bus must be terminated on the EAC side.

Figure 17. Daisy chain connected communication hubs, set DIP 6 and 7 in ON position for one communication hub

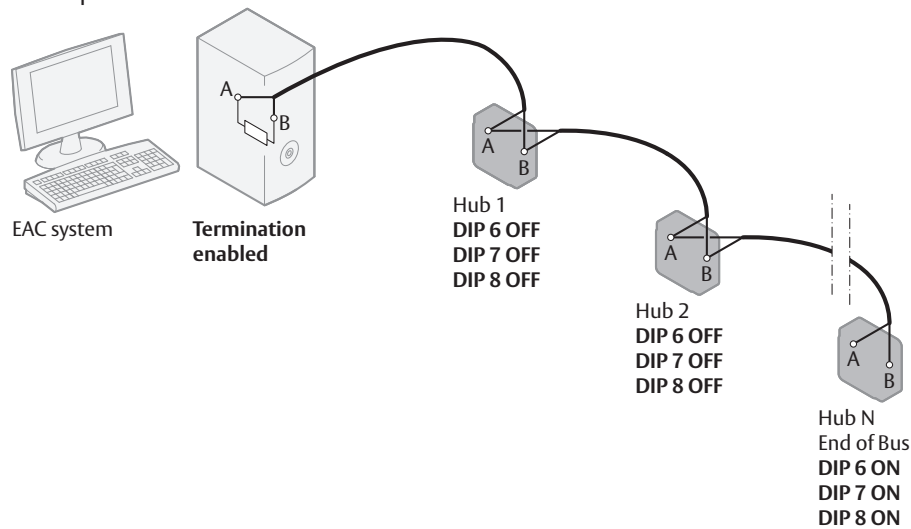

For a star connection, set DIP 6 and 7 in ON position for one communication hub. DIP 8 must be in ON position for all communication hubs. The RS-485 bus can not be terminated on the EAC side.

Figure 18. Star connected communication hubs, DIP 6 and 7 in ON position for one communication hub

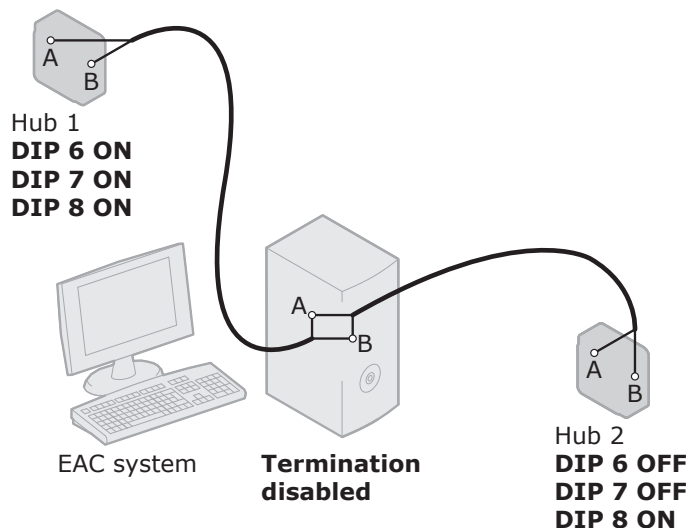

DIP 9

This DIP switch is not used.

DIP 10 – Internal/external antenna

Normally the internal antenna of the communication hub is sufficient. In a difficult installation environment or if the radio signal needs to be amplified for extended range, an external antenna can be used. Set the DIP 10 to OFF to use an external antenna.

Connecting to the RS-485 bus

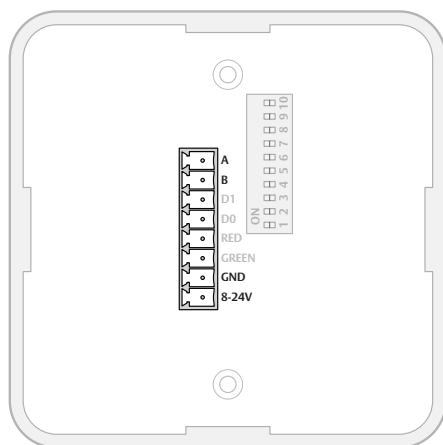

The RS-485 bus should be made up of a twisted-pair cable with characteristic impedance between 90 Ohm and 120 Ohm. Maximum bus length is about 1000 m. Depending on the EAC system, a maximum of 32 units (31 communication hubs plus the EAC, when using the DIP Switch for RS-485-addressing) can be connected to the same bus.

Connect all RS485 A connectors together and all RS485 B connectors together, depending on connection type, see *Figure 17* and *Figure 18* on page 39.

Connecting to supply voltage

Connect the wires to 8-24 VDC, 1.1 W and GND (ground) on the communication hub.

Note! The power supply shall be a Limited Power Source (LPS) according to EN 60950-1. The power supply shall be 3A over current protected. Wire requirements 16-22 AWG.

AH40 (Ethernet)

This chapter describes how to perform a default configuration of an AH40 communication hub using the Ethernet interface.

Configuration of the communication hub to the EAC includes setting jumpers, connecting it to Ethernet and connecting it to power supply, according to applicable section below.

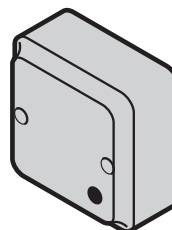

Setting jumper for internal/external antenna

Normally the communication hub's internal antenna is sufficient. In a difficult installation environment or if the radio signal needs to be amplified in a certain direction, an external antenna can be used. Connect the two left pins ("EXT") with the jumper to use an external antenna.

Setting jumper for pairing mode

To activate automatic pairing, connect the two left pins ("PAIR") with the jumper, see figure.

Connect to supply voltage

Connect the power and ground to the "+" and the "-" terminals of the connector marked "8V-24V".

Note! Power supply input, 8-24 VDC, 3.5 W. The power supply shall be a Limited Power Source (LPS) according to EN 60950-1. The power supply shall be 3 A over current protected. Wire requirements 16-22 AWG.

Connecting Ethernet

Connect an Ethernet cable to the Hub and make sure that the Ethernet "LINK" LED is green, which indicates that the Ethernet link level is established. The Hub supports 10/100 Mbit/s half and full duplex with auto-negotiation.

Using Power over Ethernet (PoE)

The communication Hub can also be powered using Power over Ethernet by connecting it to an Ethernet switch or other equipment that supports this.



Due to EMC regulations, do not connect any other power supply when PoE is used.

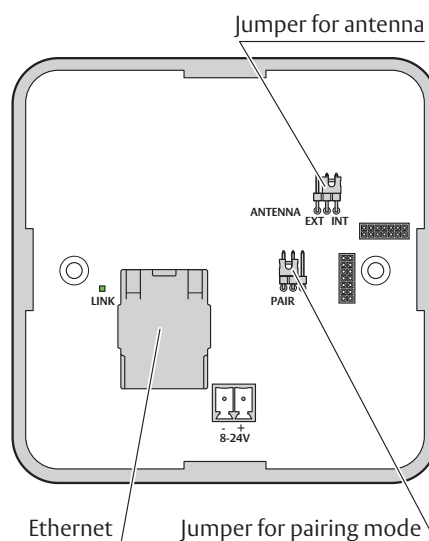

6 Appendix

Selecting the correct EAC address (AH15/AH30)

Selecting EAC addresses for communication hubs and locks correctly during installation is important in order not to cause address conflicts in your installation.

The communication hubs can use different address ranges depending on the installation:

- **Address 1-15:** For AH30 communication hubs with one or several locks paired and AH15 communication hubs. Address is selected by DIP Switch or the Programming Application.

- **Address 16-31:** For AH30/AH15 communication hubs in single device mode (only one lock paired). Address is selected by DIP Switch or the Programming Application.

- **Address 32-63:** For AH30/AH15 communication hubs in single device mode (only one lock paired). Address is selected only by the Programming Application.

The final lock EAC address depends on the communication hub address. For AH15 communication hubs the lock address is equal to the hub address. For AH30 communication hubs the lock address is decided by the addressing table.

Addressing table – normal address offset

An AH30 communication hub can pair with up to 8 locks. When pairing several locks to a communication hub, the following addresses are used for the address range 1-15. Above this range only one lock can be paired.

DIP 4 – DIP 1	AH30 Hub address	Lock addresses
0000		Reserved
0001	0x01	0x01, 0x11, 0x21, 0x31, 0x41, 0x51, 0x61, 0x71
0010	0x02	0x02, 0x12, 0x22, 0x32, 0x42, 0x52, 0x62, 0x72
0011	0x03	0x03, 0x13, 0x23, 0x33, 0x43, 0x53, 0x63, 0x73
0100	0x04	0x04, 0x14, 0x24, 0x34, 0x44, 0x54, 0x64, 0x74
0101	0x05	0x05, 0x15, 0x25, 0x35, 0x45, 0x55, 0x65, 0x75
0110	0x06	0x06, 0x16, 0x26, 0x36, 0x46, 0x56, 0x66, 0x76
0111	0x07	0x07, 0x17, 0x27, 0x37, 0x47, 0x57, 0x67, 0x77
1000	0x08	0x08, 0x18, 0x28, 0x38, 0x48, 0x58, 0x68, 0x78
1001	0x09	0x09, 0x19, 0x29, 0x39, 0x49, 0x59, 0x69, 0x79
1010	0x0A	0x0A, 0x1A, 0x2A, 0x3A, 0x4A, 0x5A, 0x6A, 0x7A
1011	0x0B	0x0B, 0x1B, 0x2B, 0x3B, 0x4B, 0x5B, 0x6B, 0x7B
1100	0x0C	0x0C, 0x1C, 0x2C, 0x3C, 0x4C, 0x5C, 0x6C, 0x7C
1101	0x0D	0x0D, 0x1D, 0x2D, 0x3D, 0x4D, 0x5D, 0x6D, 0x7D
1110	0x0E	0x0E, 0x1E, 0x2E, 0x3E, 0x4E, 0x5E, 0x6E, 0x7E
1111	0x0F	0x0F, 0x1F, 0x2F, 0x3F, 0x4F, 0x5F, 0x6F, 0x7F

When configuring installations that differ from the default configuration described in section DIP 1-5 – Selecting the EAC address/Automatic pairing on page 38, use this table to keep track

of what addresses are used by the locks/sensors in your installation in order to avoid addressing conflicts according to section "Installation examples" on page 44 for mixed installations.

Addressing table – legacy address offset

Legacy addressing mode is an alternative addressing mode that can be set by the Programming Application in the configuration wizard. The lock addresses in this mode are set consecutively. For example, if communication hub has address 1, the locks will get address 1-8, 9-16, 17-24 etc.

DIP 5 – DIP 1	AH30 Hub address	Lock addresses
0000		Reserved
0001	0x01	0x01, 0x02, 0x03, 0x04, 0x05, 0x06, 0x07, 0x08
0010	0x02	0x09, 0x0A, 0x0B, 0x0C, 0x0D, 0x0E, 0x0F, 0x10
0011	0x03	0x11, 0x12, 0x13, 0x14, 0x14, 0x16, 0x17, 0x18
0100	0x04	0x19, 0x1A, 0x1B, 0x1C, 0x1D, 0x1E, 0x1F, 0x20
...		

This mode is used for older EAC systems that cannot handle high EAC addresses where the limit for example is 32 or 64.

Installation examples

See below for examples of the most common installations and how the addressing is made and how possible address conflicts are avoided.

One-to-several installation

This is the default installation as described in section "DIP 1-5 – Selecting the EAC address/ Automatic pairing" on page 37, with up to 15 AH30 communication hubs paired with one or several locks. Only the addresses 1-15 are used.

The addressing table above does not need to be consulted in this type of installation, since all the lock addresses used are unique. Addressing is simply made by selecting a unique address for each communication hub.

Figure 19. One-to-several installation

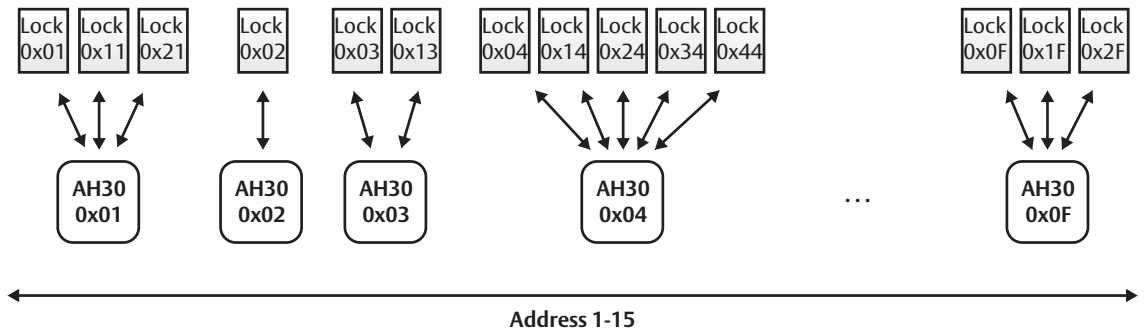

Mixed installation

A mixed installation uses both AH15 and AH30 communication hubs with the address range from 1 to 63, according to this figure:

Figure 20. Mixed installation

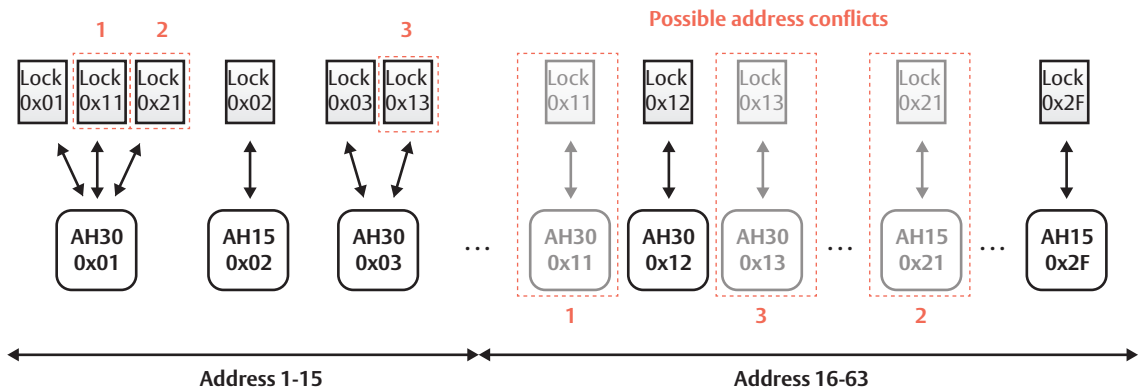

In the address range 1-15, AH30 communication hubs can be used to pair several locks. In the address range 16-63 only AH15 or AH30 communication hubs in single device mode can be used to pair with only one lock. Some

of these locks create possible address conflicts: 0x11, 0x21 and 0x13. These conflicts are simply avoided by selecting the closest "free" address, in this case 0x12.

Figure 21. Single device installation

Single device installation

A single device installation uses only AH15 communication hubs with the address range from 1 to 63, according to this figure:

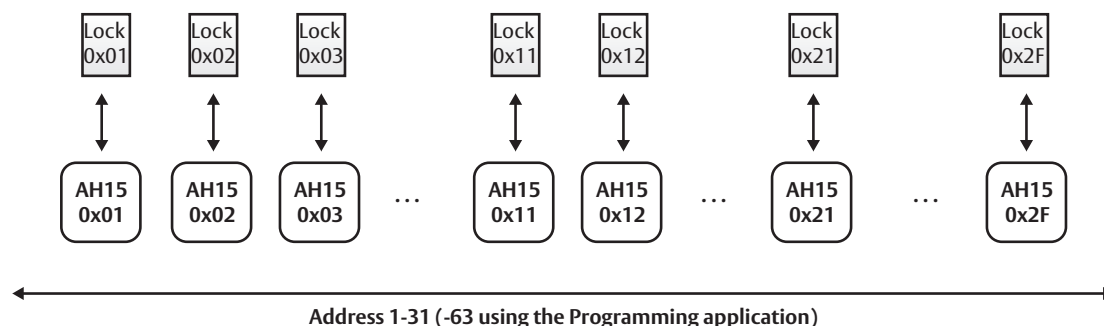

In this installation example, no address conflicts will occur since the lock address is equal to the communication hub address (and provided that the DIP Switches are set correctly with a unique address for each communication hub).

Upgrading existing installations

When upgrading existing installations with new locks or/and communication hubs or replacing old hardware a general guideline is to first write down the EAC addresses used originally in the installation and consult the addressing table when adding AH30 communication hubs.

Replacement of communication hubs in single device mode

When replacing AH15/AH30 communication hubs that are paired with one lock with a new/reused communication hub, always make sure that the replacement communication hub does not have any locks paired. If so use the Programming Application to unpair any locks.

Upgrading firmware in AH30 communication hubs

The latest firmware (2.6.0 or later) for AH30 communication hubs adds the functionality to use DIP Switch addresses in the range of 16-31 (DIP switch 5).

Before upgrading make sure that your existing AH30 communication hubs do not have DIP 5 activated. If DIP 5 is activated and the communication hub is paired with only one lock,

the firmware upgrade will result in that the EAC address is changed according to DIP 5, for both the communication hub and the lock.

Upgrading an AH15 installation with one-to-several AH30 communication hubs

If a maximum of 15 communication hubs will be used after the upgrade, no address conflict will occur, provided that all communication hubs use a unique address. If more than 15 communication hubs are used in the resulting installation, address conflicts can occur when adding AH30 communication hubs in the address range of 1-15 with several locks paired.

- 1) Note the EAC addresses used in existing installation.
- 2) Consult the AH30 addressing table and select an EAC address that is not in conflict with already installed AH15 communication hubs in the address range 15-63.
- 3) If address conflicts occur you must change the EAC address of one or several existing AH15 communication hubs. Also make sure that all communication hubs are using a unique address.

7 LED Indications

Communication Hub LED indications

The communication hub has a single LED. It supports an optical scheme with red, green and yellow. The indication scheme is described by the two figures below:

Figure 22. Communication hub normal operation LED indication

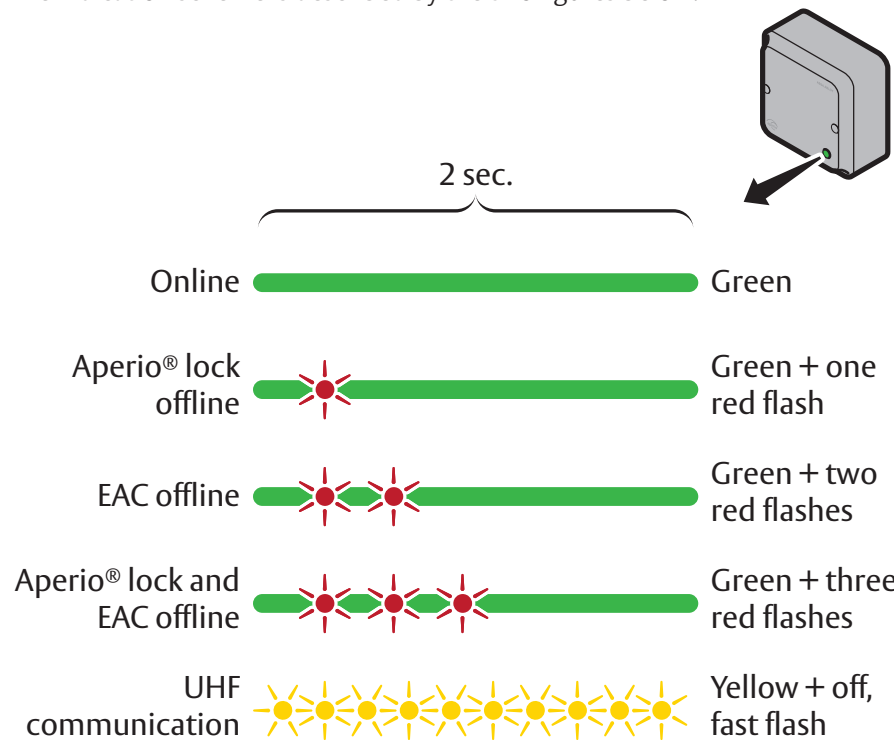

Some special LED indication schemes are used during lock maintenance actions:

Figure 23. Communication Hub maintenance LED indication

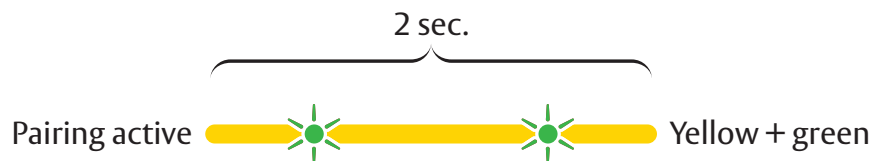

AH40 Ethernet LED indication

The LED on the AH40 communication hub indicates both the status of the Ethernet link level and ethernet communication:

Figure 24. AH40 Communication hub Ethernet LED indication

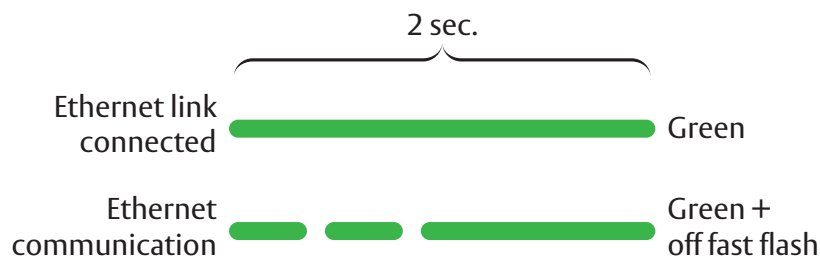

Lock LED indications

The lock has three LEDs. They support an optical scheme with red, yellow and green. The indication scheme is described by the figures below:

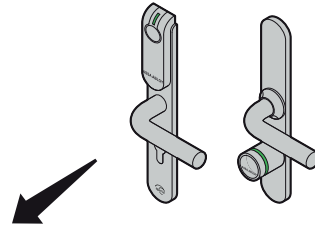
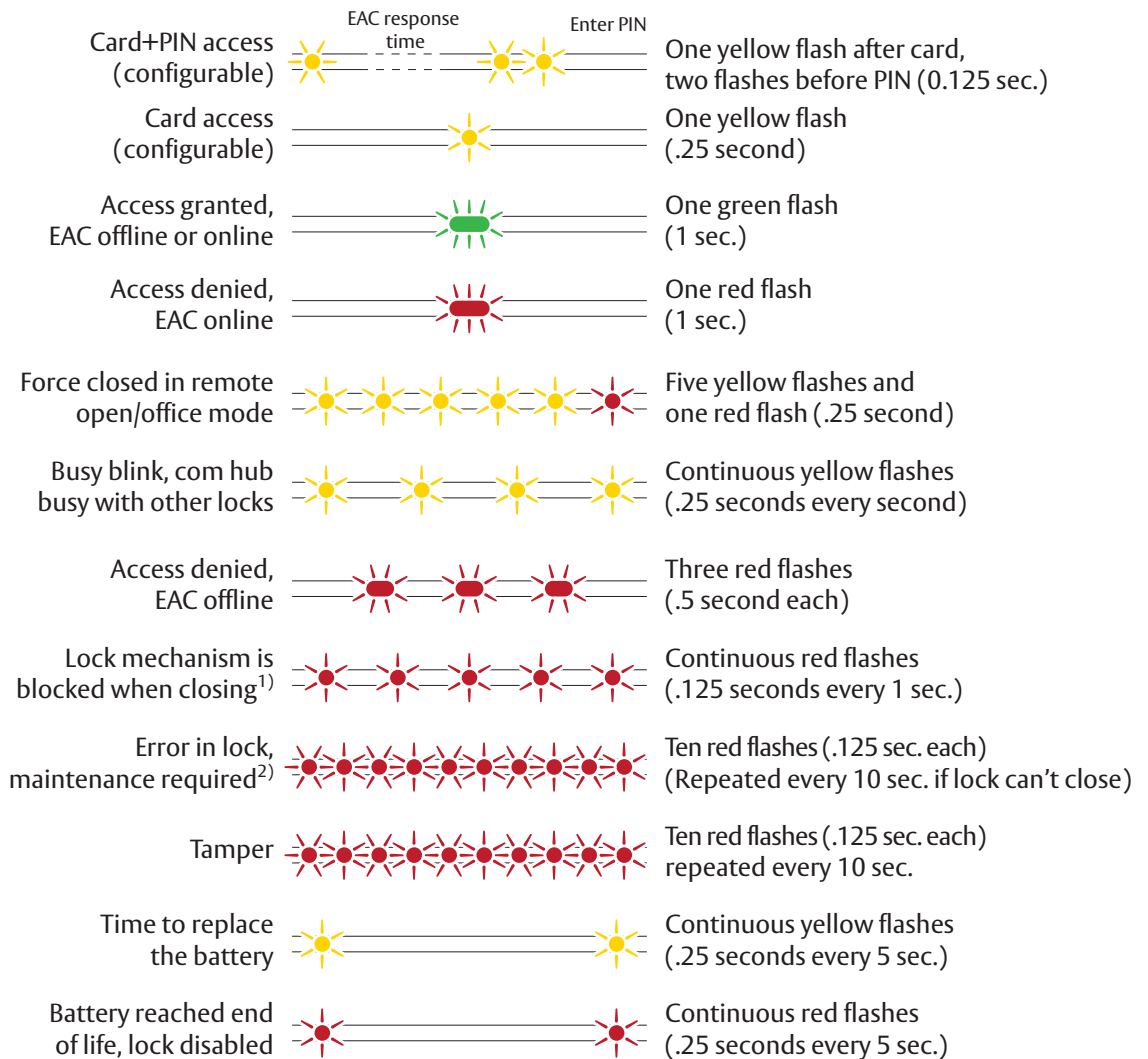

Figure 25. Lock normal operation LED indication



i 1) When the lock mechanism is blocked (lock jammed) the knob must be turned/handle released, to release the lock mechanism.

i 2) The “Error in lock” indication is also shown instead of the POST flashes if the battery is not accepted as new after a power-on-reset.

Some special LED indication schemes are used during lock maintenance actions:



Figure 26. Lock hub normal operation LED indication

ASSA ABLOY is the
global leader in door
opening solutions,
dedicated to satisfying
end-user needs for
security, safety and
convenience

ASSA ABLOY

Contact

www.assaabloy.com/aperio

